

~ TABLE OF CONTENTS ~

ADHESIVES	38-40, 57	MESH TRUCK COVER	17
AUTOMOTIVE ITEMS	57-58	MONOFILAMENT THREAD	36
BOBBINS	34-36	NAILS	25-26
BOLSTERS (POLYFOAM)	11	NEEDLES	53-55
BONDED CUSHION WRAP	13	NO-SAG CLIPS	28
BUNGI / SHOCK CORD	59	NO-SAG SPRINGS	28
BURLAP	17	PANEL BOARDS	57
BUTTONS, DIES & CUTTERS	31-32	PILLOW INSERTS	14
BUTTON MACHINE	31	PLASTIC BAGS	5
BUTTON MOULDS	32	PLI-GRIP (FABRI-FAST)	21
BUTTON TUFTER	32, 50	POLYSCRIM	11
BUTTON TWINE	37	POLYFOAM	9-12
CAMBRIC & NON-WOVEN DUST CLOTH	16	RAZOR BLADES	59
CANE (CHAIR)	30	ROCKER BASES	27
CARPET PAD (AUTOMOTIVE)	14,58	ROCKER SPRINGS	27
CASTERS	42	RUBBER WEBBING	22
CHALK	23	SHEARS	48
CHURCH SEATING FOAM	12	SHOCK CORD / BUNGI	59
COIL SPRINGS	29	SILICONE SPRAY	39
COTTON FELT	13	SKIRT LINING	17
CUSHION FILLING	4, 5	SNAP FASTENERS	46
CUSHION UNITS	27	SPRING REPAIR BRACKET	28
CUSHION WRAP	13	SPRING TWINE	37
DACRON	13	SPRINGS (UPHOLSTERY)	28-29
DENIM (DECK CLOTH)	16	STAPLERS & STAPLES	43-45
DOWNY SOFT PILLOW FILLER	13	STEAMERS	47
DRY-FAST FOAM CUSHIONS	11	STITCHING TWINE	37
DUCK & CANVAS	17	SUPERFOAM	7-8, 12
EK CLIPS & EK NAILS	28	SWIVELS	27
EDGE WIRE & CLIPS	29	T-NUTS	41
EDGE ROLL	29	T-PINS	54
FABRI-FAST (PLI-GRIP)	21	TACKS	26
FOAM	7-12	TACKING STRIP	21
FOAM SAWS	6	THREAD	34-37
GENERAL PURPOSE CLIPS	57	TOOLS	49-52
GIMP SCROLL	20	TORSION SPRINGS	29
GLIDES	41	TUFTING NEEDLE	50
GLUE & CEMENT	38-40, 57	TWINE (BUTTON)	37
GLUE GUN	38	TWIST PINS	54
GROMMETS & DIES	33	UPHOLSTERY PINS	54
HAIRFLEX	14	UPHOLSTERY TEXT BOOK	49
HEADLINER & CLIPS	57	VELCRO TYPE HOOK AND LOOP	24
HOG RINGS (SEAT COVER TIES)	55	VENTILATORS	33
HOG RING PLIERS	56	WEBBING	22
HOOK & LOOP (VELCRO TYPE)	24	WELT CORD	23, 58
LACQUER SPRAY	15	WOVEN CANE	30
LEGS	41	ZIPPERS	18-19

~COMPANY POLICIES~

DEAR CUSTOMER:

ALL PRICES IN THIS CATALOG ARE NET WHOLESALE.

DUE TO FUTURE VOLATILITY OF FUEL AND SHIPPING COSTS ALL PRICES ARE SUBJECT TO CHANGE WITHOUT NOTICE.

IN ORDER TO PROVIDE YOU WITH THE BEST POSSIBLE SERVICE, WE MAINTAIN LARGE INVENTORIES OF ALL OUR PRODUCTS. ALL SHIPMENTS ARE FOB OUR WAREHOUSE UNLESS QUOTED OTHERWISE. YOU HAVE THE OPTION TO SPECIFY METHOD OF SHIPMENT, UPS, FEDEX GROUND, U.S.P.S., OR COMMON MOTOR CARRIER. IF YOU DO NOT SPECIFY A METHOD, WE WILL USE OUR JUDGEMENT IN SELECTING THE MOST ECONOMICAL CARRIER.

ORDERS ARE FILLED ON A FIRST-COME FIRST-SERVED BASIS. ALL ORDERS RECEIVED PRIOR TO **2:30 P.M. CENTRAL TIME** WILL BE SHIPPED THE SAME DAY. ALL REQUESTS AFTER **2:30 P.M. CENTRAL TIME** WILL BE SHIPPED THE FOLLOWING DAY.

SPECIAL SHIPPING NOTICE

WE COMPRESS FOAM AND BONDED CUSHION WRAPS TO REDUCE THE SIZE OF THE PACKAGE. REDUCING THE SIZE SAVES A MINIMUM OF \$10.00 PER PACKAGE IN SHIPPING FEES BECAUSE UPS AND FEDEX GROUND CHARGE FOR THESE ITEMS BASED ON PACKAGE SIZE, NOT WEIGHT. PLEASE REMOVE THE ITEM FROM THE PACKAGE AS SOON AS YOU RECEIVE IT. AFTER OPENING THE PACKAGE, THESE PRODUCTS GO BACK TO THEIR ORIGINAL SIZE AND SHAPE.

IT IS YOUR RESPONSIBILITY TO NOTE WITH THE CARRIER ANY SHIPMENT THAT ARRIVES INCOMPLETE OR DAMAGED IN ORDER FOR US TO SUCCESSFULLY FILE A CLAIM ON YOUR BEHALF.

CREDIT

ALL ORDERS WILL BE SHIPPED C.O.D. OR ON A CREDIT CARD UNLESS CREDIT HAS BEEN PREVIOUSLY APPROVED BY OUR CREDIT DEPARTMENT.

IN ORDER FOR US TO ACCEPT CHECKS ON C.O.D. SHIPMENTS, WE MUST HAVE ON FILE YOUR BANK'S NAME, ACCOUNT NUMBER, AND DRIVER'S LICENSE NUMBER OF EACH PERSON SIGNING CHECKS. OTHERWISE PAYMENT MUST BE MADE VIA CREDIT CARD, CASHIERS CHECK, OR MONEY ORDER.

CASH CUSTOMERS MUST HAVE A CASHIER'S CHECK/MONEY ORDER FOR THE EXACT AMOUNT OF THE SHIPMENT. UPS AND FEDEX DO NOT ACCEPT CASH AND REQUIRE CORRECT AMOUNTS ON CASHIERS CHECKS AND MONEY ORDERS. WE WILL CALL YOU AT THE END OF THE DAY WITH THE EXACT AMOUNT OF YOUR ORDER.

RETURNS

OUR PERMISSION MUST BE OBTAINED FOR MERCHANDISE RETURNS. A RESTOCKING FEE MAY BE CHARGED ON RETURNED MERCHANDISE; HOWEVER, WE DO NOT ACCEPT CUTS OF 3 YARDS OR LESS FOR CREDIT ON ACCOUNT UNLESS WE SHIPPED IN ERROR. WE DO NOT ACCEPT RETURNS ON DISCONTINUED PATTERNS OR CLOSEOUTS. NON-STOCK SPECIAL ORDER ITEMS WILL BE SUBJECT TO SUBSTANTIAL RESTOCKING AND FREIGHT CHARGES. IN SOME CASES, SPECIAL ORDER ITEMS MAY NOT BE RETURNED. REQUESTS FOR RETURNS MUST BE MADE WITHIN 30 DAYS OF PURCHASE DATE, AND A COPY OF OUR INVOICE OR INVOICE NUMBER MUST BE PROVIDED ON THE RETURNED ITEMS.

FLAMMABILITY STANDARDS

ANY AND ALL DATA REFERRING TO FLAMMABILITY STANDARDS IN OUR PRICE LISTS AND ON OUR SAMPLES SHOULD NOT BE CONSTRUED TO IMPLY THE BEHAVIOR OF ANY ITEM OR MATERIAL UNDER ACTUAL FIRE CONDITIONS.

ALL RIGHTS RESERVED. NOTHING IN THIS CATALOG MAY BE COPIED OR REPRODUCED WITHOUT WRITTEN PERMISSION FROM MOSEHART SCHLEETER Co., INC.

WE ACCEPT MASTERCARD, VISA, AMERICAN EXPRESS, & DISCOVER CARDS

~ IMPORTANT INFORMATION ~

TO EXPEDITE YOUR ORDERS

WE HAVE MANY ACCOUNTS WITH THE SAME NAME IN DIFFERENT CITIES, SO PLEASE GIVE YOUR ACCOUNT NUMBER WHEN ORDERING. ***PLEASE GIVE QUANTITY, STOCK NUMBER, DESCRIPTION, PATTERN AND COLOR OF ITEMS DESIRED.***

FABRIC AND VINYL

FEEL FREE TO ASK ABOUT OUR FABRIC AND VINYL SAMPLE BOOKS. WE CARRY AN ASSORTMENT OF FABRIC PATTERNS IN A WIDE VARIETY OF COLORS AND TEXTURES. VINYL PATTERNS ARE FROM NAUGAHYDE, BOLTAFLEX, NASSIMI AND SPRADLING. ALL FABRICS AND VINYL ARE DISPLAYED ON OUR WEBSITE AT www.m-sfabrics.com.

SELLER SHALL NOT BE LIABLE FOR ANY DELAY IN DELIVERY OR NON-DELIVERY OF MERCHANDISE DUE TO SHIPPING/PACKAGING COMPANY DELIVERY ERROR, ACCIDENTS, STRIKES, FIRES, FLOODS, GOVERNMENT REGULATION DELAY, OR INABILITY TO OBTAIN MERCHANDISE THROUGH SELLER'S USUAL AND REGULAR SOURCES, OR ANY OTHER CONDITIONS BEYOND THE CONTROL OF SELLER.

SELLER SHALL NOT BE LIABLE FOR NORMAL MANUFACTURING DEFECT NOR FOR CUSTOMARY VARIATIONS FROM CHARACTERISTICS OF QUALITY OR ACCEPTABLE VARIATIONS OF COLOR FROM SAMPLES.

CLEANING AND CARE GUIDELINES ARE AVAILABLE ON OUR FABRIC AND VINYL PATTERNS.

SEE OUR SEPARATE PRICE LISTS FOR FABRIC, VINYL AND LEATHER

IMPORTANT NOTICE

MATERIAL SAFETY DATA SHEETS (MSDS) ARE AVAILABLE ON ALL HAZARDOUS MATERIALS IN THIS CATALOG, AND CAN BE PROVIDED TO YOU UPON REQUEST.

IT IS YOUR RESPONSIBILITY TO DETERMINE THE GUIDELINES AND REQUIREMENTS CONCERNING THE USE OF HAZARDOUS MATERIALS UNDER THE OCCUPATIONAL SAFETY AND HEALTH ACT (OSHA) WHEN THEY ARE USED IN YOUR BUSINESS.

*****WARNING*****

URETHANE FOAM IS FLAMMABLE

DO NOT EXPOSE URETHANE FOAMS TO OPEN FLAMES OR INDIRECT HIGH TEMPERATURE IGNITION SOURCES SUCH AS BURNING OPERATIONS, WELDING, BURNING CIGARETTES, SPACE HEATERS OR NAKED LIGHTS

ONCE IGNITED, URETHANE FOAMS WILL BURN RAPIDLY, RELEASING GREAT HEAT AND CONSUMING OXYGEN AT A HIGH RATE. IN AN ENCLOSED SPACE, THE RESULTING DEFICIENCY OF OXYGEN WILL PRESENT A DANGER OF SUFFOCATION TO THE OCCUPANTS. HAZARDOUS GASES RELEASED BY THE BURNING FOAM CAN BE INCAPACITATING OR FATAL TO HUMAN BEINGS IF INHALED IN EXCESSIVE QUANTITIES

BY USING OUR COPYRIGHTED SYSTEM BELOW, YOU DO NOT NEED EXPENSIVE CUSHION FILLING MACHINES. ALL YOU NEED IS A VACUUM CLEANER WITH HOSE ATTACHMENT AND OUR PLASTIC FILLING BAGS LISTED ON THE NEXT PAGE.

~ CUSHION FILLING ~



STEP 1. INSERT THE FOAM FILLER OR SPRING UNIT INTO A THIN PLASTIC BAG. THESE CAN BE DACRON OR COTTON FELT WRAPPED.

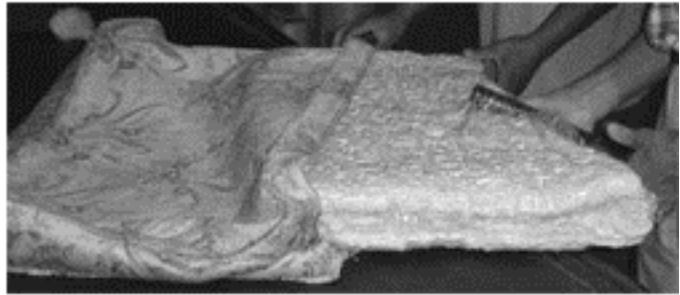
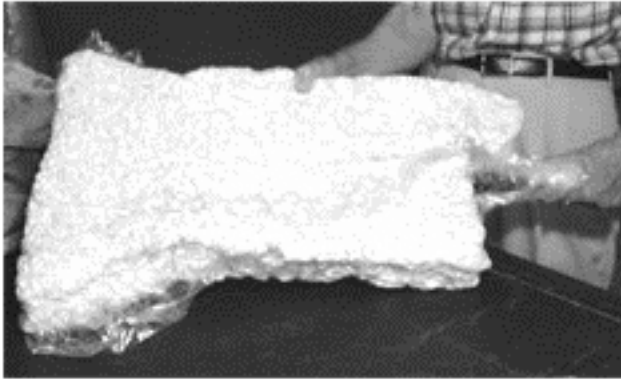

STEP 2. INSERT THE VACUUM CLEANER HOSE INTO THE BAG, GRASP PLASTIC AROUND THE HOSE AIRTIGHT, OR FOLD THE PLASTIC BAG AND PUNCH A SMALL HOLE IN THE BOTTOM OF THE BAG AND INSERT THE HOSE INTO THE HOLE. THIS WILL MAKE IT EASIER TO REMOVE THE PLASTIC BAG BY UNFOLDING THE ENDS AND PULLING THE BAG OUT OF THE CUSHION. NOW START YOUR VACUUM CLEANER AND REMOVE ALL THE AIR FROM THE BAG AND FILLER. PLACE THE DEFLATED FILLER INTO THE CUSHION COVER.



STEP 3. YOU MAY THEN REMOVE THE PLASTIC BAG, OR LEAVE IT IN THE CUSHION TO PROTECT AGAINST SPILLS.

Copyright © 1980

Oklahoma Upholstery Supply, INC.

~ PLASTIC BAGS & INSTRUCTIONS ~

CUSHION FILLING BAGS

SEE PREVIOUS PAGE FOR HOW TO USE THESE BAGS TO FILL CUSHIONS.

STOCK No.	SOFA BAGS	BOX OF 12	BOX OF 50	BOX OF 100	BOX OF 300
93450	SOFA BAGS 36" X 55"	\$6.00	\$22.50	\$40.00	\$105.00

ADDITIONAL INFORMATION ON HOW TO FILL CUSHIONS USING PLASTIC BAGS AND A VACUUM CLEANER TO VACUUM AIR OUT OF CUSHION TO REDUCE SIZE OF FILLER.

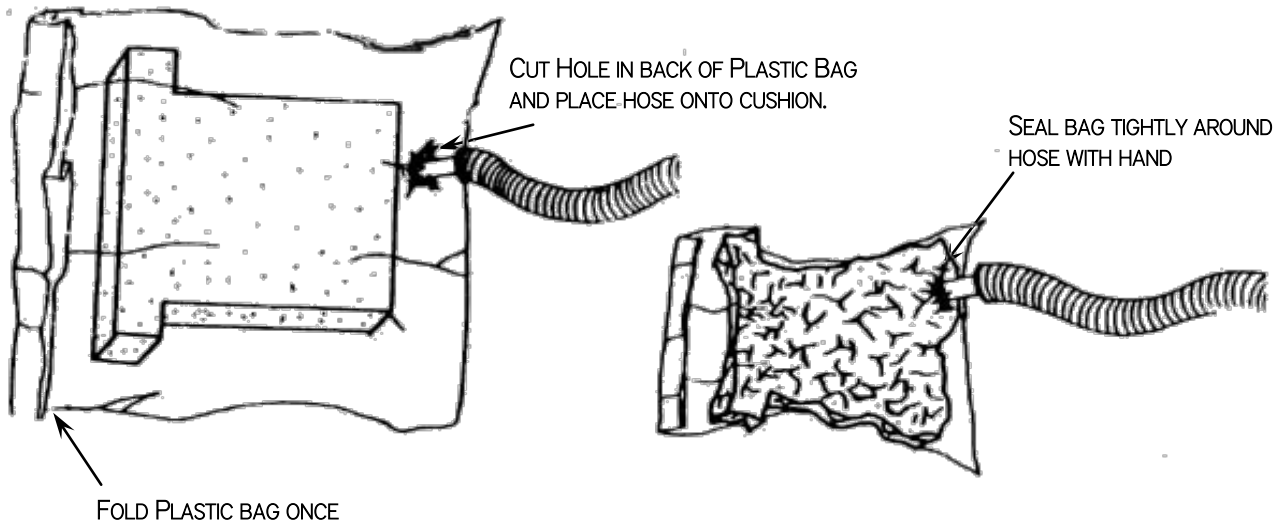

STEP 1: PUT CUSHION UNIT INTO PLASTIC BAG WITH FRONT OF CUSHION TOWARD OPENING OF BAG. CUT A SMALL HOLE AT THE BACK OF THE BAG FOR VACUUM HOSE.

STEP 2: SEAL BAG BY FOLDING OPENING FLAPS OVER ONE TIME. INSERT HOSE INTO OPENING AT OTHER END AND CLOSE PLASTIC BAG AROUND HOSE. GRASP TIGHTLY TO SEAL.

STEP 3: START VACUUM CLEANER TO COMPRESS CUSHION BEFORE INSERTING INTO FABRIC CUSHION FORM.

Cushion Filling System
Copyright © 1980

~FOAM SAWS~

EZ FOAM SAW

STOCK No.	EZ FOAM SAW & BLADES	EACH
60512	EZ FOAM SAW / WITH 8" BLADE	\$175.00
60513	8" BLADE SET FOR EZ FOAM SAW	9.95

- LIGHT WEIGHT
- REMOVABLE FOOT
- CUTS FOAM UP TO 7 1/2" THICK
- CUTS SHARP TURNS WITH EASE

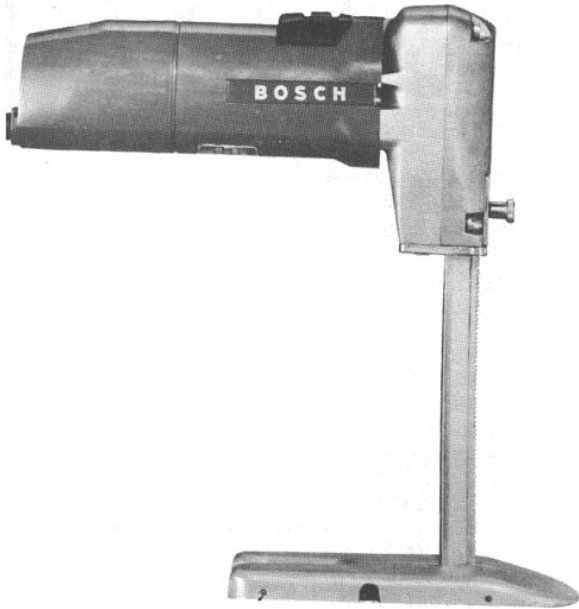

BOSCH FOAM SAW

STOCK No.	BOSCH FOAM SAW & BLADES	EACH
80028	BOSCH FOAM SAW, WITH 12" BLADE	\$640.00
80030	BOSCH FOAM SAW, WITH 8" BLADE	630.00

REPLACEMENT PARTS

80029	BOSCH FOAM SAW MOTOR UNIT	\$440.00
80031	8" BOSCH BLADE SET	48.75
80032	12" BOSCH BLADE SET	52.95
80033	12" GUIDE FOR BOSCH SAW	105.95
80034	8" GUIDE FOR BOSCH SAW	94.95
80035	BOSCH FOOT PLATE	148.25

THE BOSCH FOAM SAW IS PRECISION DESIGNED WITH THE FOLLOWING FEATURES: SLIM 2 1/4" DIAMETER, 3 1/2 LBS. DOUBLE INSULATED MOTOR, PRECISION GROUND STAINLESS STEEL BLADES EASY TO GUIDE ON ROLLER BEARING FOOT PLATE. WILL CUT A VARIETY OF FOAM AND CARPET.

~SUPERFOAM SHEETS~

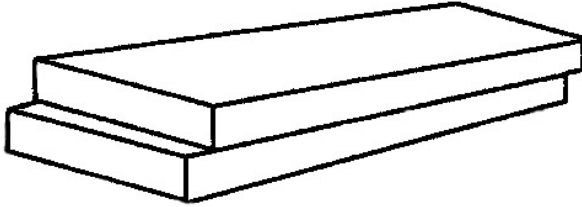

MADE FROM URETHANE. DOES NOT DETERIORATE.
THIS FOAM MEETS FLAMMABILITY STANDARDS OF CALIF 117.

27 TO 33 LB ILD AT 25% DEFLECTION
2.4 TO 2.5 LBS DENSITY PER CU.FT.

SHEET LENGTH APPROX. 82"

STOCK No.	4" SUPERFOAM SHEETS	EACH	4 OR MORE, EACH
42284	4" X 22" X 82" SUPERFOAM SHEETS	\$90.00	\$81.00
42484	4" X 24" X 82" SUPERFOAM SHEETS	96.00	86.00
42684	4" X 26" X 82" SUPERFOAM SHEETS	104.00	94.00
44884	4" X 48" X 82" SUPERFOAM SHEETS	192.00	172.00

STOCK No.	5" SUPERFOAM SHEETS	EACH	4 OR MORE, EACH
52284	5" X 22" X 82" SUPERFOAM SHEETS	\$112.00	\$101.00
52484	5" X 24" X 82" SUPERFOAM SHEETS	120.00	108.00
52684	5" X 26" X 82" SUPERFOAM SHEETS	125.00	113.00
54884	5" X 48" X 82" SUPERFOAM SHEETS	240.00	216.00

STOCK No.	6" SUPERFOAM SHEETS	EACH	4 OR MORE, EACH
62284	6" X 22" X 82" SUPERFOAM SHEETS	\$137.00	\$124.00
62484	6" X 24" X 82" SUPERFOAM SHEETS	144.00	130.00
62684	6" X 26" X 82" SUPERFOAM SHEETS	149.00	135.00

STOCK No.	SUPERFOAM SHEETS	EACH	6 OR MORE, EACH
12480	1" X 24" X 82" SUPERFOAM SHEETS	\$24.00	\$22.00
14880	1" X 48" X 82" SUPERFOAM SHEETS	48.00	44.00
24805	1 1/2" X 24" X 82" SUPERFOAM SHEETS	36.00	33.00
48805	1 1/2" X 48" X 82" SUPERFOAM SHEETS	72.00	66.00
22480	2" X 24" X 82" SUPERFOAM SHEETS	48.00	44.00
24880	2" X 48" X 82" SUPERFOAM SHEETS	96.00	88.00
32480	3" X 24" X 82" SUPERFOAM SHEETS	72.00	65.00
34880	3" X 48" X 82" SUPERFOAM SHEETS	144.00	130.00

Warning! – Urethane Foam Burns
See Page 3

~ SUPERFOAM CUSHIONS ~

MADE FROM URETHANE. DOES NOT DETERIORATE.
THIS FOAM MEETS FLAMMABILITY STANDARDS OF
CALIF 117.

PLEASE CALL US WITH CUSHION DIMENSIONS FOR
PRICING & DELIVERY ON SPECIAL SIZE CUSHIONS.

27 TO 33 LB ILD AT 25% DEFLECTION
2.4 TO 2.5 LB DENSITY PER CU.FT.

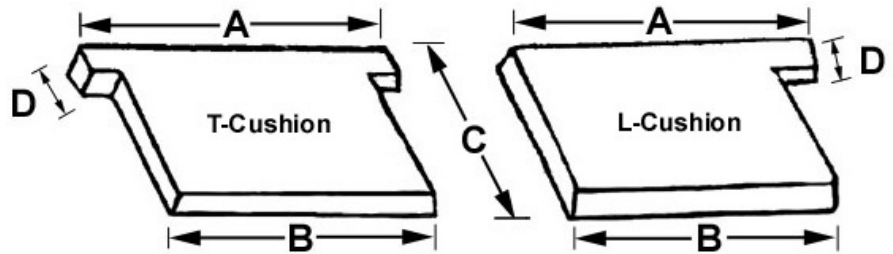

CUT TO ORDER – GIVE THESE DIMENSIONS WHEN ORDERING “T” OR “L”

Stock No.	4" SUPERFOAM CUSHIONS	EACH
42424	4" x 24" x 24" SUPERFOAM CUSHIONS	\$40.00
42624	4" x 24" x 26" SUPERFOAM CUSHIONS	41.60
Stock No.	5" SUPERFOAM CUSHIONS	EACH
52424	5" x 24" x 24" SUPERFOAM CUSHIONS	\$50.00
52426	5" x 24" x 26" SUPERFOAM CUSHIONS	52.00
Stock No.	6" SUPERFOAM CUSHIONS	EACH
62424	6" x 24" x 24" SUPERFOAM CUSHIONS	\$60.00

SEE OUR SYSTEM FOR FILLING CUSHIONS ON PAGES 4 AND 5 FOR AN EASY WAY TO FILL YOUR CUSHIONS.

****Warning! – Urethane Foam Burns****
See Page 3

~ POLYFOAM SHEETS AND ROLLS ~

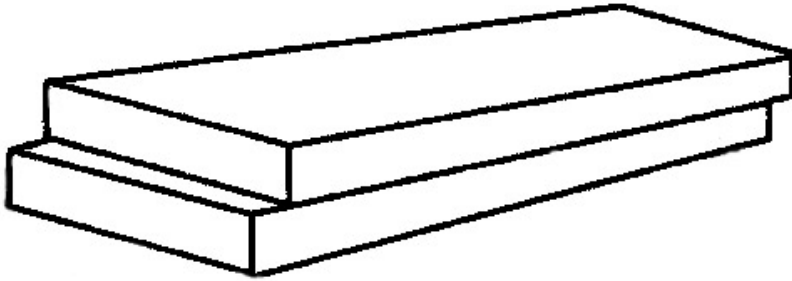

MADE FROM URETHANE
THIS FOAM MEETS FLAMMABILITY
STANDARDS OF CALIF 117.

33 TO 39 LB ILD AT 25% DEFLECTION
1.0 TO 1.1 LB DENSITY PER CU.FT.

SHEET LENGTH APPROX. 82"

STOCK NO.	4" POLYFOAM SHEETS	EACH	4 OR MORE, EACH
42272	4" x 22" x 82" POLYFOAM SHEETS	\$48.00	\$44.00
42472	4" x 24" x 82" POLYFOAM SHEETS	52.00	48.00
44872	4" x 48" x 82" POLYFOAM SHEETS	104.00	96.00

STOCK NO.	5" POLYFOAM SHEETS	EACH	4 OR MORE, EACH
42476	5" x 24" x 82" POLYFOAM SHEETS	\$64.00	\$58.00
42477	5" x 48" x 82" POLYFOAM SHEETS	128.00	116.00

STOCK NO.	POLYFOAM SHEETS	EACH	6 OR MORE, EACH
10025	1/4" x 24" x 82" POLYFOAM SHEETS	\$10.00	\$9.00
10050	1/2" x 24" x 82" POLYFOAM SHEETS	11.00	10.00
12472	1" x 24" x 82" POLYFOAM SHEETS	13.00	12.00
10500	1 1/2" x 24" x 82" POLYFOAM SHEETS	19.50	18.00
22472	2" x 24" x 82" POLYFOAM SHEETS	26.00	24.00
32472	3" x 24" x 82" POLYFOAM SHEETS	39.00	36.00
14872	1" x 48" x 82" POLYFOAM SHEETS	26.00	24.00
48725	1 1/2" x 48" x 82" POLYFOAM SHEETS	39.00	36.00
24872	2" x 48" x 82" POLYFOAM SHEETS	52.00	47.00
34872	3" x 48" x 82" POLYFOAM SHEETS	78.00	71.00

STOCK NO.	ROLLS OF POLYFOAM (DOES NOT MEET CALIF. 117)	EACH	6 OR MORE, EACH
24550	1/2" x 24" x 50 FT. ROLL OF POLYFOAM	\$53.00	\$48.00
24150	1" x 24" x 25 FT. ROLL OF POLYFOAM	53.00	48.00

****Warning! – Urethane Foam Burns****
See Page 3

~ POLYFOAM CUSHIONS & BACK FOAM ~

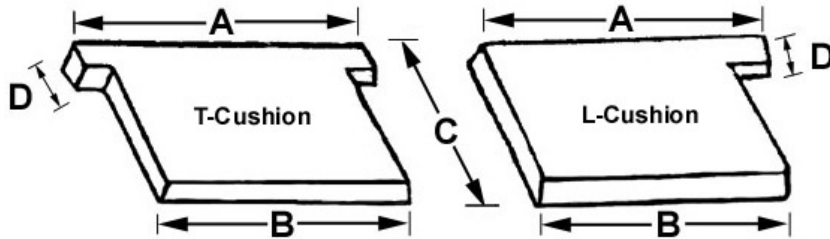

CUT TO ORDER – GIVE THESE DIMENSIONS WHEN ORDERING “T” OR “L”

MADE FROM URETHANE
THIS FOAM MEETS FLAMMABILITY
STANDARDS OF CALIF 117.

PLEASE CALL US WITH CUSHION DIMENSIONS FOR
PRICING ON SPECIAL SIZE CUSHIONS.

**28 TO 34 LB ILD AT 25% DEFLECTION
1.0 TO 1.1 LB DENSITY PER CU.FT.**

Stock No.	4" POLYFOAM CUSHIONS		EACH
24244	4" x 24" x 24"	POLYFOAM CUSHIONS	\$26.40
24264	4" x 24" x 26"	POLYFOAM CUSHIONS	27.45

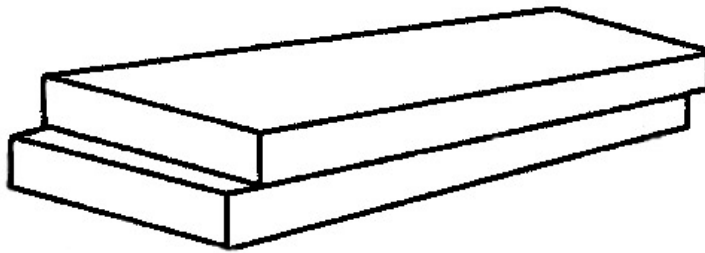

POLY BACK FOAM EXTRA SOFT FOR BACKS ONLY.

MADE FROM URETHANE.
THIS FOAM MEETS FLAMMABILITY STANDARDS OF CALIF 117.

**16 TO 20 LB ILD AT 25% DEFLECTION
1.75 TO 1.85 LB DENSITY PER CU.FT.**

SOLD IN FULL 82" SHEETS ONLY

Stock No.	POLY BACK FOAM SHEETS		EACH	4 OR MORE, EACH
60032	2" x 24" x 82"	POLY BACK FOAM SHEETS	\$39.00	\$36.00
60031	3" x 24" x 82"	POLY BACK FOAM SHEETS	58.50	54.00
60030	4" x 24" x 82"	POLY BACK FOAM SHEETS	78.00	71.00

SEE OUR SYSTEM FOR FILLING CUSHIONS ON PAGES 4 AND 5 FOR AN EASY WAY TO FILL YOUR CUSHIONS.

****Warning! – Urethane Foam Burns****
See Page 3

~ POLYSCRIM & POLYFOAM BOLSTERS ~

POLYSCRIM – SEW FOAM (WITH REINFORCED BACKING)

IDEAL FOR CHANNELING OR QUILTING.

CAN BE USED FOR PADDING ARMS AND BACK AS WELL AS MANY OTHER USES.

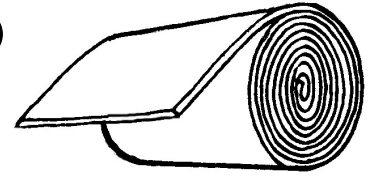

STOCK No.		EACH	6 OR MORE, EACH
92460	1/2" x 28" x 50FT ROLL	\$82.00	\$74.00

POLYSCRIM – SEW FOAM (FLAME RETARDANT)

MEETS MOTOR VEHICLE MVSS-302 & CALIF TECHNICAL BULLETIN 117 FLAMMABILITY STANDARDS.

STOCK No.		EACH	6 OR MORE, EACH
97300	1/2" x 28" x 50FT ROLL	\$107.00	\$96.50

POLYFOAM BOLSTERS

THIS FOAM MEETS FLAMMABILITY STANDARDS OF CALIF 117.

STOCK No.	POLYFOAM ROUND BOLSTERS	EACH	4 OR MORE, EACH
11636	6" ROUND BOLSTER, 36" LONG	\$12.95	\$11.65
11936	9" ROUND BOLSTER, 36" LONG	25.95	23.50



DRY-FAST FOAM CUSHIONS

POROUS FAST DRYING FOAM AT 33LB ILD FOR OUTDOOR APPLICATIONS

MAXIMUM LENGTH: 96 INCHES

OTHER WIDTHS ARE AVAILABLE, CALL FOR PRICING

ALLOW 2 TO 3 DAYS FOR FABRICATION

PRICED PER INCH BASED ON LENGTH	PER INCH
1" x 24"	\$0.75
2" x 24"	1.50
3" x 24"	2.20
4" x 24"	3.00



33 LB ILD – 24" WIDE

Warning! – Urethane Foam Burns

See Page 3

~ VIRGIN ~ HIGH DENSITY ~ CHURCH SEATING FOAMS ~

EXTRA FIRM VIRGIN

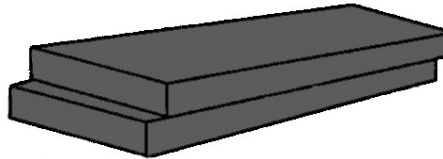

61 TO 68 LB ILD AT 25% DEFLECTION
1.30 TO 1.36 LB DENSITY PER CU.FT.

FULL SHEETS ONLY

STOCK No.	SHEET LENGTH APPROX. 82"	EACH	4 OR MORE, EACH
60021	1" x 24" x 82" CHARCOAL EXTRA FIRM	\$17.50	\$16.00
60019	1 1/2" x 24" x 82" CHARCOAL EXTRA FIRM	26.25	24.00
60022	2" x 24" x 82" CHARCOAL EXTRA FIRM	35.00	32.00
60023	3" x 24" x 82" CHARCOAL EXTRA FIRM	52.50	48.00
60024	4" x 24" x 82" CHARCOAL EXTRA FIRM	70.00	63.00

TOO FIRM FOR USE ON FURNITURE. APPROPRIATE FOR TRACTOR SEATS, SCHOOL BUS SEATS, CHURCH KNEELING PADS, EXERCISE PADS

HIGH DENSITY
(HIGH D) FOAM

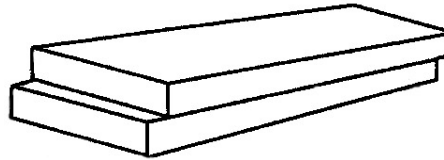

45 TO 55 LB ILD AT 25% DEFLECTION
2.50 LB DENSITY PER CU.FT.

FULL SHEETS ONLY

THIS FOAM MEETS FLAMMABILITY STANDARDS OF CALIF 117.

STOCK No.	SHEET LENGTH APPROX. 82"	EACH	4 OR MORE, EACH
65721	1" x 24" x 82" HIGH D FOAM SHEETS	\$23.50	\$21.25
65722	2" x 24" x 82" HIGH D FOAM SHEETS	47.00	42.50
65723	3" x 24" x 82" HIGH D FOAM SHEETS	70.50	63.75
65724	4" x 24" x 82" HIGH D FOAM SHEETS	94.00	85.00
65728	4" x 48" x 82" HIGH D FOAM SHEETS	188.00	170.00

THIS FOAM HAS MANY USES INCLUDING OFFICE FURNITURE AND CHAIRS, BOOTHS, TIGHT SEAM FURNITURE, ANTIQUES, OR FURNITURE CUSHIONS WHERE A VERY FIRM CUSHION IS DESIRED.

BOTH FOAMS MEET FLAMMABILITY STANDARDS OF
CALIF. 117

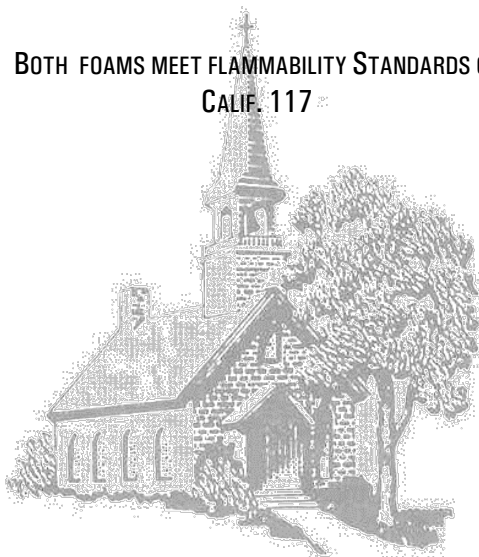

CHURCH SEATING - SUPERFOAM

STOCK No.	SHEET LENGTH APPROX. 82"	PRICE
11215	1" x 15" x 82"	\$15.50
11216	1" x 16" x 82"	15.95
21215	2" x 15" x 82"	31.00
21216	2" x 16" x 82"	31.90

CHURCH SEATING - POLYFOAM

STOCK No.	SHEET LENGTH APPROX. 82"	PRICE
11512	1" x 15" x 82"	\$8.15
11612	1" x 16" x 82"	8.65
21512	2" x 15" x 82"	16.30
21612	2" x 16" x 82"	17.30

OTHER WIDTHS OF CHURCH SEATING AVAILABLE ON REQUEST, ORDER NUMBER OF FEET DESIRED FROM THE ABOVE WIDTHS.

****Warning! – Urethane Foam Burns****
See Page 3

~ CUSHION WRAP ~ DACRON ~ COTTON ~ DOWNY SOFT ~

BONDED CUSHION WRAP

USED TO WRAP SUPERFOAM OR POLYFOAM CUSHIONS. ALSO CAN BE USED AS PADDING OVER SPRINGS.

APPROXIMATE WEIGHT PER ROLL

27" = 5 to 6 Lbs.
54" = 10 to 11 Lbs.

STOCK No.		EACH ROLL	6 ROLLS, EACH
60028	27" x 3/4 oz. x 45FT ROLL	\$25.95	\$23.35
60029	54" x 3/4 oz. x 45FT ROLL	51.90	46.70

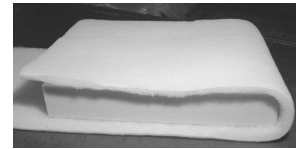

PLAIN DACRON / UNSTITCHED

RECOMMENDED FOR WRAPPING FURNITURE CUSHIONS.

STOCK No.	30" WIDE, 10 OZ. BATTING. APPROX. 15 YDS PER ROLL	PER LB.
60041	PLAIN DACRON APPROX 12LB ROLLS	\$4.95
	APPROX 80LB BALES	4.45

QUILTED DACRON (CHEESECLOTH-STITCHED)

RECOMMENDED FOR WRAPPING FURNITURE CUSHIONS. CHEESECLOTH-STITCHED ON ONE SIDE TO MAKE SOFTER CUSHIONS.

STOCK No.	30" WIDE, 10 OZ. BATTING. APPROX. 15 YDS PER ROLL	PER LB.
60039	QUILTED DACRON APPROX 12 LB ROLL	\$5.25
	APPROX 80 LB BALE	4.75

COTTON FELT

27" WIDE

STOCK No.	100% NEW MATERIAL	PER LB.
60038	COTTON FELT APPROX 25 LBS PER ROLL	\$1.95
	APPROX 100 LBS PER BALE	1.75



DOWNY SOFT

PILLOW FILLER – REPLACEMENT FOR KAPOK

100% POLYESTER BLEND – SQUEEZE ABLY SOFT - GENTLE SUPPORT - RESILIENT - LASTING PLUMPNESS

STOCK No.		EACH	2 OR MORE, EACH
60063	DOWNY SOFT, PACKED IN 10 LB BAG	\$80.95	\$72.85



~ CARPET PAD ~ HAIRFLEX ~ THROW PILLOWS ~

CARPET PAD – (JUTE FELT)

HAS MANY USES, SUCH AS A COVER OVER ARMS AND SPRINGS

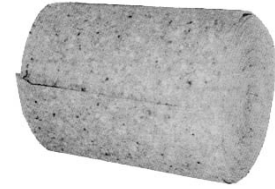

STOCK No.	APPROX 3/8" THICK, 36" WIDE, 27 OZ.	PER YD.	25 YDS., PER YARD	50 YDS, PER YARD
7620TA	JUTE CARPET PAD, 36" WIDE	\$5.50	\$5.25	\$4.95

RUBBERIZED CURLED HAIR (HAIRFLEX)



STOCK No.		EACH	6 OR MORE, EACH
60043	1" X 24" X 72" SHEETS	\$15.95	\$14.35

THROW PILLOW INSERTS

THESE INSERTS ARE COVERED IN WHITE POLYPROPYLENE, AND FILLED WITH POLYESTER FIBERS. THESE INSERTS ARE NOT PERFECTLY SQUARE BUT WILL FILL TO THE SHAPE OF YOUR PILLOW WHEN THEY ARE INSERTED INTO PILLOW FORM.



STOCK No.	SQUARE PILLOW INSERTS	EACH	12 OR MORE, EACH
64716	16" X 16" SQUARE PILLOW INSERTS	\$5.95	\$5.35
64718	18" X 18" SQUARE PILLOW INSERTS	6.95	6.25
64726	24" X 24" SQUARE PILLOW INSERTS	10.95	9.85

~ LACQUER SPRAY ~

CYPRESS LACQUER - WOOD FINISH

STOCK No.	AVAILABLE COLORS
84101	101 TRUE MAHOGANY
84103	103 TRUE WALNUT
84104	104 CORDOVAN MAHOGANY
84108	108 DEEP WALNUT
84110	110 BROWN MAHOGANY
84117	117 TRUE MAPLE

STOCK No.	AVAILABLE COLORS
84119	119 MEDIUM WALNUT
84201	201 NATURAL WALNUT
84205	205 NATURAL OAK
84301	301 SATIN CLEAR FLAT
84303	303 GLOSS CLEAR
84306	306 SANDING SEALER
84402	402 EBONY BLACK



16oz. SPRAY CAN

NOTE: DUE TO REGULATIONS, AEROSOL CANS MUST BE SHIPPED IN A CORRUGATED BOX AND CAN NOT BE SHIPPED BY AIR.

	PER CAN, EACH	12 PER CASE, EACH
LACQUER WOOD FINISH	\$10.95	\$9.85

WOVEN FABRIC WITH CRYPTON® FINISH

OUR CRYPTON® COLLECTION | FABRICS WITH THE CRYPTON® PROTECTIVE FINISH OFFER THE ULTIMATE STAIN RESISTANCE AND CLEANABILITY AVAILABLE IN A WOVEN FABRIC.

FEATURES:

- MOISTURE RESISTANT
- STAIN RESISTANT
- WATER REPELLENT
- ANTI-MICROBIAL
- INCREASED DURABILITY & BREATHABILITY
- ENHANCED ABRASION RESISTANCE
- RETAINS SOFT HAND

APPLICATIONS:

- CONTRACT & RESIDENTIAL
- HEALTHCARE
- HOTEL & HOSPITALITY
- RESTAURANT & DAY CARE
- CHURCH
- LUGGAGE

FOR APPLICATIONS THAT DO NOT REQUIRE THE HIGH DEGREE OF PROTECTION OFFERED BY THE CRYPTON® FINISH, FABRICS ARE AVAILABLE WITH THE STANDARD TEFLON® FINISH.

~ Non-Wovens ~ Cambric ~ Denim ~ Muslin ~

NON-WOVEN FABRIC

(DECK CLOTH)

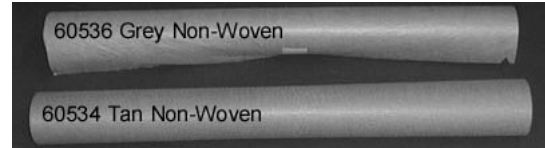

STOCK NO.		PER YARD	10 YD CUTS, PER YARD	100 YD ROLLS, PER YARD
60534	36" WIDE TAN NON-WOVEN	\$2.95	\$2.75	\$2.65
60536	36" WIDE GREY NON-WOVEN	2.95	2.75	2.65

CAMBRIC

(DUST CLOTH)

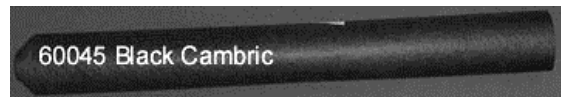

STOCK NO.	30" WIDE	PER YARD	10 YD CUTS, PER YARD	100 YD ROLLS, PER YARD
60045	#45 BLACK NON-WOVEN CAMBRIC	\$1.95	\$1.85	\$1.75

SPUNBOUND POLYPROPYLENE OLEFIN

(DUST CLOTH)

SPUN BLACK AND SPUN WHITE ARE MADE OF **SPUNBOUND POLYPROPYLENE OLEFIN**. THIS ITEM IS TERRIFIC FOR LOW-PRICE CAMBRIC AND CUSHION WRAP. IT IS STRONG, SOFT, & SEWABLE.

STOCK NO.		100 YARD ROLL	5 ROLLS, PER ROLL
60538	#38 SPUN BLACK 36" WIDE (FULL ROLLS ONLY)	\$38.70	\$34.85
60539	#39 SPUN WHITE 30" WIDE (FULL ROLLS ONLY)	57.50	51.75

HIGH-LUSTER DENIM

(DECK CLOTH)

SAND HI-LUSTER DENIM WILL BLEND WITH MOST FABRICS.

STOCK NO.	100% COTTON – 30" WIDE	PER YARD	10 YD CUTS, PER YARD	100 YD ROLLS, PER YARD
60057	HI-LUSTER GRAY	\$2.45	\$2.35	\$2.20
60059	HI-LUSTER SAND	2.30	2.20	2.10
60069	HI-LUSTER BROWN	2.45	2.35	2.20

MUSLIN (100% COTTON)

60060	MUSLIN, NATURAL – 48" WIDE	\$3.25	\$3.10	\$2.95
-------	----------------------------	--------	--------	--------

~ JUTE BURLAP ~ SKIRT LINING ~ CANVAS ~ MESH COVER ~

JUTE BURLAP



STOCK No.		PER YD.	10 YD CUTS, PER YD.	50 YD ROLL, PER YD.
60066	JUTE BURLAP 40" X 10 OZ.	\$1.75	\$1.65	\$1.60

SKIRT LINING 100% POLYESTER

MADE ESPECIALLY TO LINE SKIRTS,
STIFFENS THE SKIRT TO PROVIDE A FINISHED LOOK.



STOCK No.	FULL ROLLS ONLY	EACH	6 OR MORE, EACH
60540	6" WIDE, MEDIUM WEIGHT, 100 YARD ROLL	\$30.95	\$27.85
60548	8" WIDE, MEDIUM WEIGHT, 100 YARD ROLL	40.50	36.45

DUCK & CANVAS

THIS DUCK CLOTH IS IDEAL FOR COVERING CUTTING TABLES, FURNITURE, SLEEPER-BED SPRINGS, AND MANY OTHER USES.

STOCK No.	10/12 OZ. PER SQUARE YARD UNBLEACHED & UNTREATED	PER YARD	50 YARD ROLL, PER YARD
60064	72" WIDE, 100% COTTON DUCK (NATURAL)	\$7.50	\$6.95
1907IV	60" WIDE, 100% COTTON DUCK (IVORY)	6.45	5.75

MESH TRUCK COVER

MULTI-COLORED. COLOR VARIES FROM ROLL TO ROLL AS THIS PRODUCT IS WOVEN FROM SURPLUS VINYL-COATED POLYESTER YARN. EACH WIDTH CONTAINS MANY DIFFERENT COLORS AND PATTERNS. RESISTANT TO ROT AND MILDEW AND FLAME RETARDANT. IDEAL FOR COVERING GRAVEL, COAL, OR OTHER PRODUCTS TO KEEP THEM FROM BLOWING OR FALLING OUT OF A TRUCK.

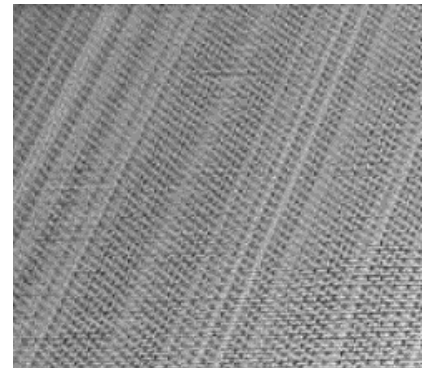

STOCK No.		PER YARD	100 YARD ROLL, PER YARD
1972ME	MESH TRUCK COVER, 72" WIDE	\$6.95	\$6.45

~ ZIPPERS ~

READY-MADE ZIPPERS #10 NYLON

DOUBLE PULL SEPARATING ZIPPERS FOR MARINE, AUTO & OUTDOOR USE.
NON-CORROSIVE ENAMEL-COATED METAL SLIDERS.

HEAVY DUTY



Stock No.	No. 10 READY MADE NYLON ZIPPERS	EACH	10 OR MORE, EACH
60608	48" No. 10 WHITE MARINE ZIPPER	\$6.75	\$6.10
60610	54" No. 10 WHITE MARINE ZIPPER	7.25	6.60
60612	60" No. 10 WHITE MARINE ZIPPER	7.95	7.15
60614	72" No. 10 WHITE MARINE ZIPPER	8.75	7.90
60616	84" No. 10 WHITE MARINE ZIPPER	9.50	8.55
60638	48" No. 10 BLACK MARINE ZIPPER	6.75	6.10
60640	54" No. 10 BLACK MARINE ZIPPER	7.25	6.60
60642	60" No. 10 BLACK MARINE ZIPPER	7.95	7.15
60644	72" No. 10 BLACK MARINE ZIPPER	8.75	7.90
60646	84" No. 10 BLACK MARINE ZIPPER	9.50	8.55

ORDER BY LENGTH

9/16" WHITE TAPE

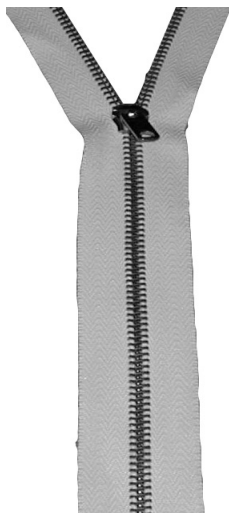

WHITE PINLOCK ZIPPERS #5 BRASS

Stock No.	No. 5 BRASS ZIPPERS	EACH	LOT OF 12, EACH
60121	18" #5 WHITE PINLOCK ZIPPER 9/16"	\$2.20	\$2.00
60122	24" #5 WHITE PINLOCK ZIPPER 9/16"	2.60	2.35
60123	27" #5 WHITE PINLOCK ZIPPER 9/16"	2.70	2.45
60124	30" #5 WHITE PINLOCK ZIPPER 9/16"	2.85	2.60
60125	36" #5 WHITE PINLOCK ZIPPER 9/16"	3.00	2.70
60126	40" #5 WHITE PINLOCK ZIPPER 9/16"	3.15	2.85
60127	54" #5 WHITE PINLOCK ZIPPER 9/16"	4.00	3.60
60128	72" #5 WHITE PINLOCK ZIPPER 9/16"	5.25	4.75
64762	24" #5 BLACK PINLOCK ZIPPER 9/16"	1.95	1.85
		EACH	LOT OF 12, EACH
64781	24" 2.5CF, 7/16" NYLON BLACK ZIPPER	\$1.35	\$1.25

ZIPPER TAPE & SLIDES

9/16" WHITE TAPE, 100 Yd ROLLS . MATCHING SLIDES SOLD IN PACKAGES OF 100.

Stock No.	BRASS ZIPPER TAPE	EACH	2+ ROLLS, EACH
60129	#5 BRASS ZIPPER TAPE, 100 YD ROLL	\$175.45	\$157.90
60130	#5 GILT ZIPPER SLIDES, PINLOCK, PKG OF 100	15.95	
ALUMINUM ZIPPER TAPE			
60455	#5 ALUMINUM TAPE, 150 YD ROLL	\$103.50	\$93.15
60457	#5 ALUMINUM ZIPPER SLIDES, PINLOCK, PKG OF 100	20.95	

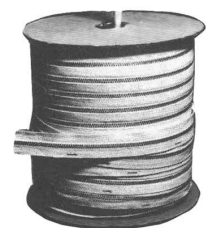

XYZ ZIPPER TAPE & SLIDES

1/2" 4.5 XYZ NYLON COIL, 100 YD ROLLS . MATCHING SLIDES SOLD IN PACKAGES OF 100.

STOCK No.	XYZ NYLON COIL ZIPPER TAPE	EACH	2+ ROLLS, EACH
60520	1/2" 4.5 WHITE ZIPPER TAPE, 100 YD ROLL	\$27.90	\$25.25
60522	1/2" 4.5 BEIGE ZIPPER TAPE, 100 YD ROLL	27.90	25.25
60524	1/2" 4.5 BLACK ZIPPER TAPE, 100 YD ROLL	27.90	25.25
STOCK No.	PINLOCK SLIDES	EACH	
60521	4.5 WHITE PINLOCK SLIDES, PKG OF 100	\$8.90	
60523	4.5 BEIGE PINLOCK SLIDES, PKG OF 100	8.90	
60525	4.5 BLACK PINLOCK SLIDES, PKG OF 100	8.90	



SEVEN MAJOR PHYSICAL PROPERTIES OF POLYURETHANE FOAM

- Density:** Indicates the molecular arrangement in the foam. It is measured in pounds per cubic foot. Density is controlled by the amount of water and/or gas producing fluorocarbon in the formulation. The more water used, the lower the density will be. Higher density means more foam, longer lasting foam, greater support retention.
- ILD:** Indentation Load Deflection-is a measurement of the firmness or load carrying capacity in pounds. There are two types of tests for ILD. One is the 25% ILD, which is the number of pounds required to indent a 50 square inch circular disc into a sample of foam. The disc is indented to a depth of 25% of the height of the sample. The second type is the 65% ILD which is measured the same as the 25% ILD but the disc is indented to a depth of 65% of the height of the sample. The 25% ILD is the method used by the furniture industry. The higher the ILD, the firmer the feel.
- Resiliency:** Indicates the amount of "spring back" in the foam. This is measured by dropping a steel ball from a height of 36 inches onto the foam sample. The height the ball bounces is compared to the 36 inches in terms of a minimum percentage. The higher the resiliency, the better the foam. Foam that has a "velvety" feel has a high resilience and a good "hand". Foam that has a harsh or rough feel is "boardy" and has a poor hand. Boardy foam has low resilience.
- Tensile:** The minimum pounds per square inch it takes to break a piece of foam by stretching.
- Elongation:** The minimum amount a piece of foam can stretch before breaking as compared to its original length.
- Tear:** The minimum amount of pounds per inch it takes to tear or split a piece of foam.
- Compression:** A measure of state of cure of a sample of foam, as well as its ability to recover its original shape after being subjected to a deforming load. In this test the foam sample is compressed and then subjected to a temperature of 158° for 22 hours. When it is released, the thickness is measured to determine the amount of loss.

SEE PAGES 7 THROUGH 12 FOR OUR AVAILABLE SELECTION OF POLYURETHANE FOAM

~ SCROLL GIMP ~

WHEN ORDERING: ASK US TO MATCH GIMP TO ANY COLOR IN YOUR FABRIC FOR YOU!

IF YOU HAVE A GIMP CHART, THE LETTER AND LAST 1 OR 2 NUMBERS IDENTIFY THE GIMP.

EXAMPLE: 990J16 IS J16



STOCK No.	COLOR
990A1	WHITE
990B1	NATURAL
990C1	KASHA
990C2	OATMEAL
990C3	SHELL
990C4	GRAIN
990C5	PINK DAWN
990C6	ECRU
990C7	DK. SAND
990C11	OYSTER
990C12	SAND STONE
990C14	DAWN
990C15	VANILLA
990C16	ALABASTER
990C17	CREAM
990C19	OFF WHITE
990C21	PARCHMENT
990C22	WHEAT
990C23	PEBBLE
990C25	IVORY
990C29	TAUPE
990D1	CHAMPAGNE
990D3	COIN GOLD
990D5	OLD GOLD
990D6	ANTIQUE GOLD
990D17	PALE BANANA
990D22	BEECHWOOD
990D24	HARVEST GOLD
990D25	GOLD
990D26	MAIZE

STOCK No.	COLOR
990E2	SEAL BROWN
990E3	BROWN
990E11	BARK BROWN
990E14	STRAW
990E15	BURNT TOAST
990E16	CAMEL
990E18	MOCHA
990E20	TOBACCO
990E24	LT. BROWN
990E26	AUBURN
990E29	BISON
990H7	EGGPLANT
990H12	DUSTY GRAPE
990H13	BLACK RUM
990J1	CHERRY
990J4	RED
990J11	MAROON
990J15	BLACK CHERRY
990J16	RUBY
990J18	WINE
990J19	CHINESE RED
990J20	DK. CLARET
990J23	CLARET
990K19	RUST
990K28	COPPER
990K32	SANDAL
990K33	CRIMSON
990K35	DK. RUST
990L5	AVOCADO
990L26	CELADON

STOCK No.	COLOR
990L28	ARTICHOKE
990L39	HUNTER GREEN
990L41	SURF
990L43	LEAF GREEN
990L44	DK. GREEN
990L46	SEACREST
990L47	GREEN MIST
990L48	SEA MIST
990L49	SAGE
990L50	DORIC KHAKI
990L52	BLACK OLIVE
990L58	BRANCH
990L60	ALPINE
990L62	HONEY DEW
990L77	CEDAR
990L79	LODEN GREEN
990L80	BEAVER
990M17	AQUATIC
990M42	DK. NAVY
990M45	FRENCH BLUE
990M51	DANUBE
990M52	MIDNIGHT
990M53	MEDIUM BLUE
990M56	PITCH
990R1	BLACK
990S21	LT. ROSE
990Y1	WHITE/GOLD
990Y4	MULTI LT. GREEN
990Y5	MULTI DK. GREEN
990Y28	GOLD/BEIGE

CUT YARDAGE	\$1.50/YARD
36 YARD PIECE	1.40/YARD
4 PIECES – 144 YARDS	1.35/YARD

~ TACKING STRIP ~

SOFT TACKING STRIP
 ½" WIDE, 3 LB. REELS



STOCK No.	APPROX. 595 FT. PER REEL	EACH	5 OR MORE, EACH
60075	Pancake Tack Strip Reels	\$7.95	\$7.15

CARDBOARD TACK STRIP
 ½" WIDE, 36" LENGTH, NO TACKS

STOCK No.	APPROX 40-45 STRIPS PER LB.	2 LBS/PER LB	10 LBS/ PER LB	50 LBS/PER LB
60076	TACK STRIPS 36" LENGTHS	\$2.95	\$2.80	\$2.65

FABRI-FAST / PLI GRIP
 3-TOOTH REGULAR



CLOSE UP VIEW

STOCK No.		EACH	5 OR MORE, EACH
60077	FABRI-FAST 100 FT. REEL	\$15.25	\$13.75

METAL TACK STRIP
 100 PER BOX

STOCK No.	FULL BOXES ONLY	EACH	5 OR MORE, EACH
60079	Metal Tack Strips	\$36.95	\$33.25

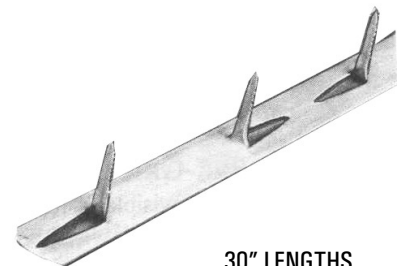

30" LENGTHS

~ WEBBING ~ WEBBING CLIPS ~

JUTE WEBBING



STOCK No.	JUTE WEBBING	EACH	5 OR MORE, EACH
60067	WEBBING (BLACK STRIPE) – 72 YD ROLLS, 3 1/2" WIDE	\$31.95	\$28.75
60068	WEBBING (RED STRIPE) – 72 YD ROLLS, 3 1/2" WIDE	37.95	34.15

RUBBER STRAPPING WEBBING
2 INCHES WIDE



STK.No. 60434 BEIGE COLOR NATURAL RUBBER WEBBING



STK.No. 60432 WHITE/BEIGE NATURAL RUBBER BLEND WEBBING

STOCK No.		PER FT.	100 FT. ROLL, PER FT.	400 FT. CASE, PER FT.
60434	BEIGE COLOR NATURAL RUBBER, PIRELLI TYPE	\$2.45	\$2.35	\$2.20
		PER FT.	150 FT. ROLL, PER FT.	450 FT. CASE, PER FT.
60432	WHITE/BEIGE NATURAL RUBBER BLEND-50% STRETCH	\$1.00	\$.95	\$.90

RUBBER
WEBBING CLIPS

STOCK No.		EACH	100 CLIPS, EACH
60435	2" WEBBING CLIPS	\$.35	\$.30

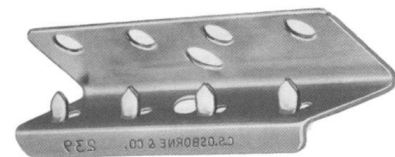

~ WELT CORD ~ CHALK ~

BRAIDED WELT CORD

500 Yards Per Reel
TISSUE CORE – POLYESTER COVER



CLOSE-UP LOOK

STOCK NO.		EACH	FULL CARTON, EACH	REELS PER CARTON
60149	5/32 BRAIDED TISSUE WELT	\$26.95	\$24.25	10
60151	6/32 BRAIDED TISSUE WELT	31.95	28.75	6
60152	8/32 BRAIDED TISSUE WELT	40.95	36.85	4

PLASTIC WELT (POLY)

STOCK NO		EACH	10 REEL CARTON
60155	5/32 PLASTIC WELT CORD, 500 YARD REEL.	\$34.95	\$31.45/EACH



DOUBLE WELT CORD

STOCK NO.	TWO BRAIDED WHITE WELT CORDS LACED TOGETHER	EACH
60156	4/32 DOUBLE WELT CORD, 350 YARD REEL	\$50.45
60157	CUT YARDAGE, DOUBLE WELT, PER YARD	.45

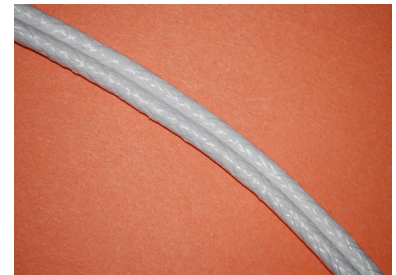

CHALK



STOCK NO.	FULL BOXES ONLY	PER BOX
60545	WHITE TAILORS CHALK, 36 Pcs.	\$11.95
60546	ASSORTED TAILORS CHALK, 36 Pcs.	14.95
60547	ROUND WHITE CHALK, 144 Pcs (12 - 12 PC. BOXES)	20.95

~ HOOK & LOOP ~



VELCRO TYPE



STICK-ON

STOCK NO.			PER YARD	25 YARD REEL/PER YARD
61470	3/4" HOOK ONLY WHITE	STICK-ON	\$1.30	\$.95
61471	3/4" LOOP ONLY WHITE	STICK-ON	1.30	.95
61473	3/4" HOOK ONLY BLACK	STICK-ON	1.30	.95
61474	3/4" LOOP ONLY BLACK	STICK-ON	1.30	.95
61415	3/4" HOOK ONLY BEIGE	STICK-ON	1.30	.95
61416	3/4" LOOP ONLY BEIGE	STICK-ON	1.30	.95
61410	1" HOOK ONLY WHITE	STICK-ON	\$1.50	\$1.05
61411	1" LOOP ONLY WHITE	STICK-ON	1.50	1.05
61412	1" HOOK ONLY BLACK	STICK-ON	1.50	1.05
61414	1" LOOP ONLY BLACK	STICK-ON	1.50	1.05
61417	1" HOOK ONLY BEIGE	STICK-ON	1.50	1.05
61418	1" LOOP ONLY BEIGE	STICK-ON	1.50	1.05
61507	2" HOOK ONLY WHITE	STICK-ON	\$3.00	\$2.10
61508	2" LOOP ONLY WHITE	STICK-ON	3.00	2.10
61495	2" HOOK ONLY BLACK	STICK-ON	3.00	2.10
61496	2" LOOP ONLY BLACK	STICK-ON	3.00	2.10
61419	2" HOOK ONLY BEIGE	STICK-ON	3.00	2.10
61420	2" LOOP ONLY BEIGE	STICK-ON	3.00	2.10

SEW-ON

Stock No.			PER YARD	25 YARD REEL/PER YARD
61440	3/4" HOOK ONLY WHITE	SEW-ON	\$.95	\$.75
61445	3/4" LOOP ONLY WHITE	SEW-ON	.95	.75
61441	3/4" HOOK ONLY BLACK	SEW-ON	.95	.75
61446	3/4" LOOP ONLY BLACK	SEW-ON	.95	.75
61421	3/4" HOOK ONLY BEIGE	SEW-ON	.95	.75
61422	3/4" LOOP ONLY BEIGE	SEW-ON	.95	.75
61501	1" HOOK ONLY WHITE	SEW-ON	\$1.10	\$.90
61502	1" LOOP ONLY WHITE	SEW-ON	1.10	.90
61504	1" HOOK ONLY BLACK	SEW-ON	1.10	.90
61505	1" LOOP ONLY BLACK	SEW-ON	1.10	.90
61423	1" HOOK ONLY BEIGE	SEW-ON	1.10	.90
61424	1" LOOP ONLY BEIGE	SEW-ON	1.10	.90
61448	2" HOOK ONLY WHITE	SEW-ON	\$1.85	\$1.60
61450	2" LOOP ONLY WHITE	SEW-ON	1.85	1.60
61449	2" HOOK ONLY BLACK	SEW-ON	1.85	1.60
61451	2" LOOP ONLY BLACK	SEW-ON	1.85	1.60
61425	2" HOOK ONLY BEIGE	SEW-ON	1.85	1.60
61426	2" LOOP ONLY BEIGE	SEW-ON	1.85	1.60

~ DECORATIVE NAILS ~

STEEL NAILS

HAMMERED OXFORD STEEL NAILS, 1/2" SHANK, 7/16" DIAMETER HEAD
BRASS FINISH, 1000 PER BOX



STOCK No.		PER BOX	5 OR MORE, EACH
60082	No. 9-L Hammered Oxford Finish Steel Nails	\$22.95	\$20.95
60084	No. 9 Plain Nickel Finish Steel Nails	23.95	21.55

FRENCH NATURAL NAIL STRIP

150 FOOT STRIP: SIMULATES HEAD-TO-HEAD NAILS

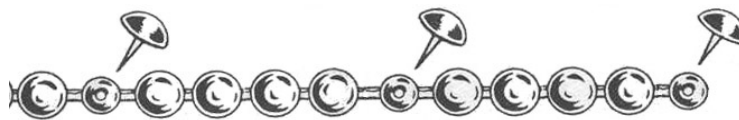

STOCK NO.		PER REEL	5 OR MORE, EACH
60091	No. 9 PLAIN FRENCH NATURAL NAIL STRIP, 150 FT REEL	\$34.45	\$31.00

FRENCH NATURAL STEEL NAILS

1/2" SHANK, 7/16" DIAMETER HEAD
NAILS TO CLOSELY MATCH THE ABOVE NAIL STRIP



STOCK No		PER BOX	5 OR MORE, EACH
60092	No. 9 PLAIN FRENCH NATURAL NAILS, 1000 PER BOX	\$26.95	\$24.95

SOLID BRASS NAILS

BRASS HEADS WILL NOT RUST
1/2" SHANK, 7/16" DIAMETER HEAD, 1000 PER BOX
SEE TOP OF PAGE FOR LESS EXPENSIVE STEEL NAILS



Natural Brass Nails
Smooth Head

Hammered Brass Nails

STOCK No.		PER BOX	5 OR MORE, EACH
60085	No. 9-L HAMMERED SOLID BRASS NAILS	\$47.95	\$43.25
60086	No. 9 NATURAL SOLID BRASS NAILS	48.95	44.25

~ DOME NAILS ~ QUICK NAILER ~ TACKS ~

DOME NAILS



STOCK No.	APPROX 100 NAILS PER PACKAGE	PER PACKAGE	5 OR MORE, PER PACKAGE
60094	5/8" DIAMETER FRENCH NATURAL STEEL NAILS	\$7.75	\$7.00
60095	3/4" DIAMETER FRENCH NATURAL STEEL NAILS	11.75	10.75
60096	1" DIAMETER FRENCH NATURAL STEEL NAILS	12.75	11.75

QUICK NAILER

HOLDS NAILS IN PLACE WHEN HAMMERING.



STOCK No.		EACH
60777	QUICK NAILER	\$9.45

TACKS

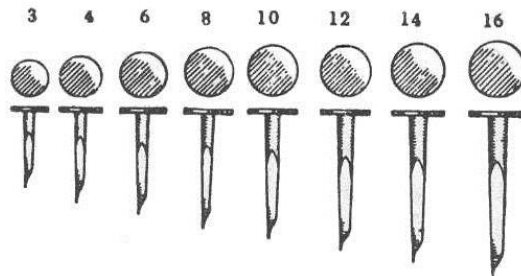

STOCK No.		PER BOX
80244	3 oz. TACKS, 1LB BOX	14.95
80245	4 oz. TACKS, 1LB BOX	14.95
80246	6 oz. TACKS, 1LB BOX	14.95
80247	8 oz. TACKS, 1LB BOX	14.95
80248	10 oz. TACKS, 1LB BOX	14.95
80249	12 oz. TACKS, 1LB BOX	14.95
80250	14 oz. TACKS, 1LB BOX	14.95
80251	16 oz. TACKS, 1LB BOX	14.95

~ CUSHION UNITS ~ SWIVELS ~ ROCKER BASES & SPRINGS ~

MARSHAL CUSHION UNITS

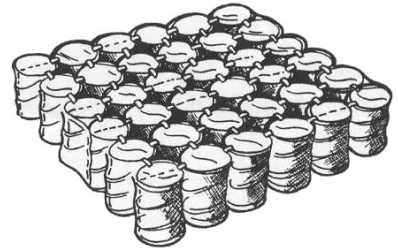

3 1/2" HIGH, 3" DIAMETER COILS, 15 GA.
COVERED IN POLYPROPYLENE OLEFIN

STOCK No.		PER UNIT	BALES OF 25, PER UNIT
60118	6 x 6, 18" x 18" HOG RINGED	\$23.95	\$21.55
60119	6 x 7, 18" x 21" HOG RINGED	25.95	23.35
60120	7 x 7, 21" x 21" HOG RINGED	30.95	27.85

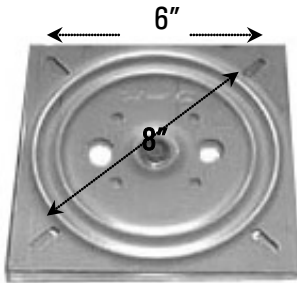

CHAIR SWIVELS
7 1/2 INCH SQUARE

NOTE: GIVEN MEASUREMENTS ARE THE MEASUREMENTS TO THE APPROXIMATE CENTER OF THE HOLES.

STOCK No.		EACH	LOT OF 5, EACH
60163	CHAIR SWIVEL	\$15.25	\$13.75

SWIVEL ROCKERS

STOCK No.		EACH	LOT OF 5, EACH
60450	SWIVEL ROCKER BASE	\$50.95	\$45.85
	REPLACEMENT SPRINGS	EACH	
60451	FRONT SPRING	\$7.95	
60452	REAR SPRING	7.95	
60453	CENTER SPRING	7.95	



HEIGHT: 5 1/4"
LEG SPAN: 25"

ROCKER SPRINGS

STOCK No.		PER PAIR	5 PAIR, PER CARTON
60162	ROCKER SPRINGS	\$9.95	\$8.95

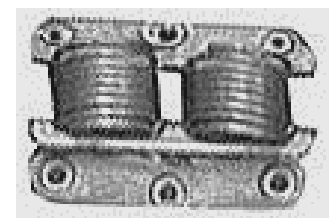

2 OF THESE = 1 PAIR

~ NO-SAG SPRINGS ~ EK-CLIPS ~ REPAIR BRACKETS ~

NO-SAG SPRINGS

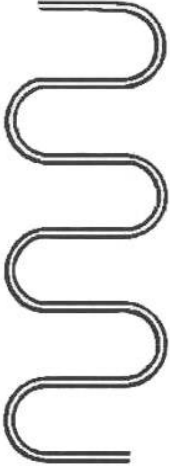
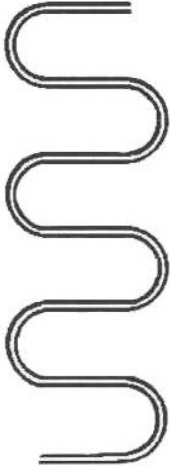

STOCK NO.		EACH	LOT OF 100, EACH
60436	24" NO SAG SPRINGS, 9 GAUGE	\$1.75	\$1.50
			5 OR MORE EACH
60437	120 FT COIL, NO-SAG SPRINGS, 9 GAUGE (FOR SEATS)	\$69.95	\$62.95
60438	140 FT COIL, NO-SAG SPRINGS, 11 GAUGE (FOR BACKS)	57.95	52.25

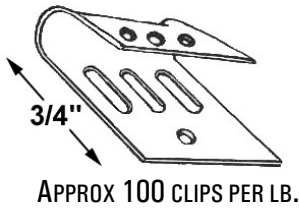

"EK" CLIPS

STOCK NO.		PER LB.	10 LBS. PER LB.
60181	EK STYLE CLIPS	\$7.95	\$7.15
60180	NAILS FOR EK CLIPS	11.75	10.75

SPRING REPAIR BRACKETS

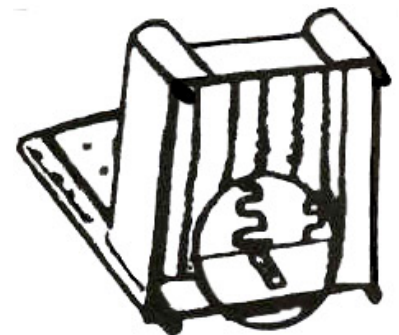
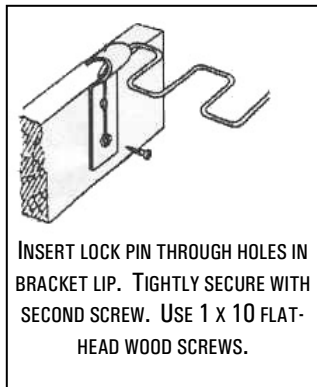
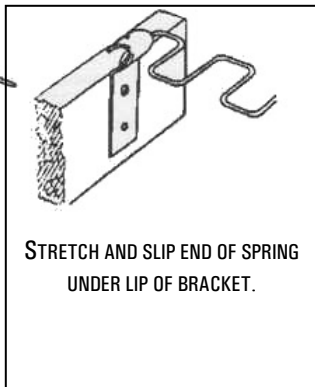
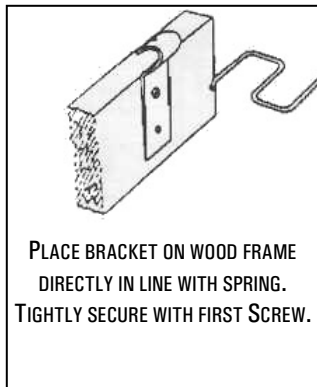

STOCK NO.		EACH	LOT OF 25, EACH
61215	REPAIR BRACKETS	\$1.95	\$1.75

~ COIL SPRINGS ~ EDGE WIRE ~ 3-PRONG CLIPS ~ TORSION SPRINGS ~ EDGE ROLL ~

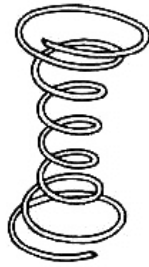

COIL SPRINGS

APPROX SPRINGS PER LB.
 6" COILS 4 SPRINGS PER LB.
 8" COILS 3 SPRINGS PER LB.
 10" COILS 2 SPRINGS PER LB.
 12" COILS 2 SPRINGS PER LB.

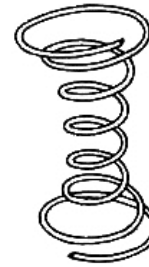

STOCK No.		LESS THAN 10 LBS, PER LB	10-49 LBS, PER LB.	50 LB BUNDLE, PER LB
60168	6" - 10 GAUGE COIL SPRINGS	\$3.95	\$3.75	\$3.55
60169	8" - 10 GAUGE COIL SPRINGS	3.95	3.75	3.55
60170	10" - 9 GAUGE COIL SPRINGS	3.95	3.75	3.55
60171	12" - 9 GAUGE COIL SPRINGS	3.95	3.75	3.55



SPRING EDGE WIRE

NOTE: EDGE WIRE WILL BE CUT INTO 5 FT. LENGTHS FOR SHIPPING IN ORDER TO COMPLY WITH UPS AND FEDEX SIZE REQUIREMENTS.



STOCK No.		EACH	LOT OF 10, EACH
60173	9 GAUGE EDGE WIRE, 10 FT LENGTHS	\$2.95	\$2.75

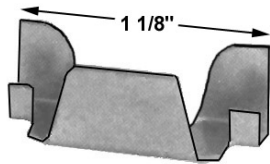

APPROX 85 CLIPS PER LB.

3 PRONG CLIPS

STOCK No.		PER LB.	5 LBS OR MORE, PER LB.
60572	3 PRONG CLIPS, 9 GAUGE	\$6.25	\$5.65

TORSION SPRINGS

STOCK No.		EACH	10 OR MORE, EACH
60448	TORSION SPRINGS	\$1.50	\$1.35

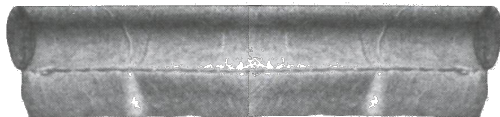

POLYFLEX SPRING EDGE

STOCK No.	50 FT COILS	PER COIL	BY THE CASE, PER COIL	COILS PER CASE
61217	1/2" SPRING EDGE POLYFLEX	\$17.95	\$16.15	15
61218	1 1/4" SPRING EDGE POLYFLEX	41.45	37.30	5

~ WOVEN CANE ~ REED SPLINE ~ HANK CANE ~

OPEN WOVEN CANE

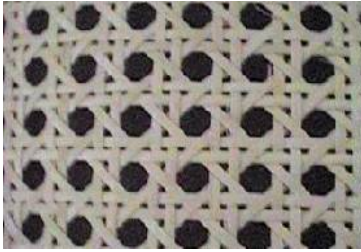

1/4" OPENING, 1/2" MESH
BLEACHED

STOCK NO.		PER LINEAR FOOT	50 FT. ROLL, PER LIN. FT.
60105	12" FINE WOVEN CANE	\$3.95	\$3.50
60106	14" FINE WOVEN CANE	4.95	4.50
60107	16" FINE WOVEN CANE	5.45	4.95
60108	18" FINE WOVEN CANE	5.95	5.50
60109	20" FINE WOVEN CANE	6.95	6.50
60111	24" FINE WOVEN CANE	7.95	7.50

CANING CHISELS

STOCK NO.		EACH
60723	#405 CANING CHISEL, 1/8"	\$16.95
60726	#405 CANING CHISEL, 3/16"	16.95

REED SPLINE

FOR FASTENING CANE INTO GROOVE OF CHAIR

APPROX 12 FT. LENGTHS

MEASUREMENTS ARE TOP WIDTH BY BOTTOM WIDTH



STOCK No.		PER FT.
60712	No. 8 LIGHT SPLINE 3/16" x 1/8"	\$.50
60713	No. 9 MEDIUM SPLINE 7/32" x 3/16"	.50
60714	No. 10 HEAVY SPLINE 1/4" x 3/16"	.50

CHAIR CANE HANK

STOCK No.		PER HANK	5+ HANKS, EACH
60115	FINE 1,000 FT HANK	\$37.45	\$33.70
60116	MEDIUM 1,000 FT HANK	50.95	45.85
60088	NARROW BINDING 3/16" 500 FT	23.95	21.55
60089	WIDE BINDING 7/32" 500 FT	21.95	19.75



~ BUTTON MACHINES ~ BUTTON DIES & CUTTERS ~ COVERED BUTTONS ~ PLASTIC BUTTONS ~



No. 1 BUTTON MACHINE

FOR USE WITH 2-PIECE BUTTON COVERING DIES.
SIMPLE CONSTRUCTION AND EASY TO OPERATE.



Stock No	DIES AND CUTTER SOLD SEPARATELY	EACH
60227	No. 1 BUTTON MACHINE	\$150.00

BUTTON MACHINE DIES AND SHORT CUTTERS

Stock No.	2-PIECE DIES FOR No. 1 BUTTON MACHINE	EACH
60228	No. 22 DIE AND CUTTER	\$87.95
60229	No. 30 DIE AND CUTTER	95.95
60230	No. 36 DIE AND CUTTER	104.95
60231	No. 40 DIE AND CUTTER	127.95
60232	No. 45 DIE AND CUTTER	142.95
60234	No. 60 DIE AND CUTTER	196.95

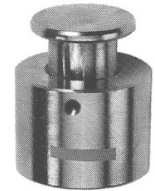

THESE DIES ARE MADE TO WORK WITH LEATHER, VINYL & FABRIC. LIGHTER WEIGHT MATERIALS MAY REQUIRE MORE THAN ONE THICKNESS OF MATERIAL OR AN EXTRA BACKING TO BE PLACED ON THE FABRIC TO PREVENT THE BUTTON FROM CUTTING THROUGH THE FABRIC.

SHORT CUTTERS ONLY

60235	No. 22 SHORT CUTTER ONLY	\$45.80
60236	No. 30 SHORT CUTTER ONLY	45.80
60237	No. 36 SHORT CUTTER ONLY	48.25
60238	No. 40 SHORT CUTTER ONLY	55.45
60239	No. 45 SHORT CUTTER ONLY	59.75
60241	No. 60 SHORT CUTTER ONLY	72.45

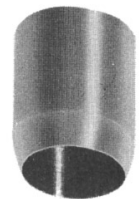

LOOP COVERED BUTTONS

WE CAN NOT COVER BUTTONS WITH HEAVY VINYL, THEREFORE, WE MAY HAVE TO USE A LIGHTER VINYL OF THE SAME APPROXIMATE COLOR TO MAKE YOUR BUTTONS.

Stock No.		EACH
60261	No. 22 LOOP COVERED BUTTONS	\$1.50
60262	No. 30 LOOP COVERED BUTTONS	1.50
60263	No. 45 LOOP COVERED BUTTONS	1.50



COVERED IN OUR FABRIC ONLY



No. 40 WHITE PLASTIC BUTTONS

Stock No.		EACH	LOTS OF 100
60225	#40 1" WHITE PLASTIC	\$.25	\$.20/EACH

RECOMMENDED FOR BUTTONING CUSHIONS WHICH ARE EXPOSED TO MOISTURE.

~ BUTTON MOULDS ~ TUFTING TOOLS ~

BUTTON MOULDS

Stock No.	WIRE EYE MOULDS – SOFT SHELL	1 GROSS BOX / PKG
60250	No. 22 9/16" WIRE EYE MOULDS	\$11.45
60251	No. 30 3/4" WIRE EYE MOULDS	12.45
60252	No. 36 7/8" WIRE EYE MOULDS	13.45
60253	No. 40 1" WIRE EYE MOULDS	15.45
60254	No. 45 1 1/8" WIRE EYE MOULDS	17.45
60256	No. 60 1 1/2" WIRE EYE MOULDS	29.95



Stock No.	PRONG MOULDS	1 GROSS BOX / PKG
60258	No. 22 9/16" PRONG MOULDS (1 1/2" PRONG)	\$15.95
60249	No. 30 3/4" PRONG MOULDS (1 1/2" PRONG)	21.45
60259	No. 36 7/8" PRONG MOULDS (1 1/2" PRONG)	22.45



PRONG TUFTING TOOL

5 1/2 INCH LONG

Stock No.		EACH
60260	PRONG TUFTING TOOL	\$16.75



STEP 1

ONCE THE TAG ENDS HAVE BEEN BROUGHT THROUGH THE BACKING, PULL BOTH STRINGS TIGHT AND TO THE CENTER OF THE QUICK-IT. THIS WILL SET YOUR BUTTON DEPTH.

TUFTING QUICK-IT

STEP 3

TO COMPLETE FASTENING THE BUTTONS, WRAP THE TAG ENDS CLOCKWISE AROUND THE QUICK-IT ONE AND A HALF TIMES AND FINISH BY BRINGING THE TWINE BACK THROUGH THE ENGAGEMENT SLOT AT THE TOP.

Introducing the **Quick-it**

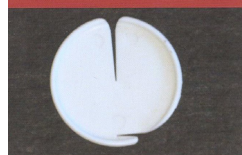

144 PCS. PER PKG.

STEP 2

AFTER YOU HAVE SET THE DEPTH, THE TAG ENDS ARE BROUGHT ACROSS THE FRONT OF THE QUICK-IT AND PLACED IN THE LOCKING HOOK AT THE BOTTOM.

STEP 4

DONE!

Stock No.		PER PKG.
60561	TUFTING QUICK-IT	\$18.95

~ GROMMETS ~ WASHERS ~ DIES ~ PUNCHES ~ PRESS-N-SNAP TOOL ~ VENTILATORS ~

GROMMETS

BRASS WITH PLAIN WASHERS – 1 GROSS PER BOX

MEASUREMENTS ARE INSIDE DIAMETER OPENING.

STOCK No.	GROMMETS & WASHERS	PER GROSS	5 GROSS, PER GROSS
60290	No. 1 5/16" GROMMETS & WASHERS	\$15.95	\$14.35
60291	No. 2 3/8" GROMMETS & WASHERS	19.95	17.95
60292	No. 3 7/16" GROMMETS & WASHERS	32.45	29.20
60330	No. 4 1/2" GROMMETS & WASHERS	38.95	35.25

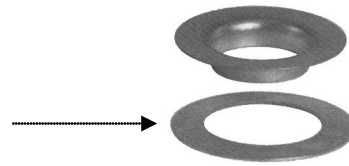

	GROMMET DIES	EACH
60293	No. 1 GROMMET DIES ONLY	\$13.25
60294	No. 2 GROMMET DIES ONLY	13.95
60295	No. 3 GROMMET DIES ONLY	14.45
60331	No. 4 GROMMET DIES ONLY	14.95
	PUNCH FOR ABOVE DIES	EACH
60296	No. 1 GROMMET PUNCH	\$37.50
60297	No. 2 GROMMET PUNCH	45.25
60298	No. 3 GROMMET PUNCH	51.50
60332	No. 4 GROMMET PUNCH	51.50

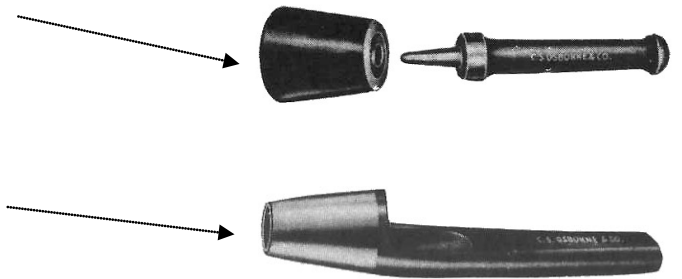

PRESS-N-SNAP TOOL

STOCK No.		EACH
93639	PRESS-N-SNAP TOOL COMPLETE KIT WITH SNAP-ON DIES & #1 GROMMET DIES	\$155.00
93645	SNAP DIES & #1 GROMMET DIES	120.00
93646	GREY RUBBER RING FOR DIES	5.00

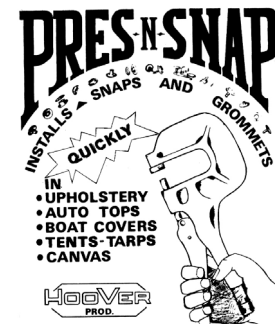

VENTILATORS

SOLID BRASS

STOCK No.		PER GROSS
60264	No. 1 PERFORATED VENTILATOR & WASHER 3/4" DIAMETER TOP	\$39.95
60265	No. 2 PERFORATED VENTILATOR & WASHER 1" DIAMETER TOP	52.50
VENTILATOR PUNCHES		EACH
60575	No. 1 VENTILATOR PUNCH 9/16"	\$37.25
60578	No. 2 VENTILATOR PUNCH 3/4"	37.95

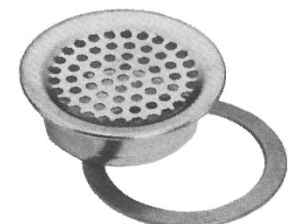

~ POLYESTER THREAD & BOBBINS ~

POLYESTER THREAD

UVR TWISTED & BONDED

ANTI-WICK FINISH

COLORFAST DYES

ULTRAVIOLET RESISTANT

SIZE B92 (16)



STOCK No.	POLYESTER THREAD 4 OZ./1500 YD TUBES	EACH	BOX OF 4 TUBES/EACH
82202	POLYESTER THREAD, 4OZ. BURGUNDY	\$16.15	\$14.55
82203	POLYESTER THREAD, 4OZ. BEIGE/FLAX	16.15	14.55
82204	POLYESTER THREAD, 4OZ. WHITE	13.75	12.50
82205	POLYESTER THREAD, 4OZ. DARK BROWN	16.15	14.55
82206	POLYESTER THREAD, 4OZ. FOREST GREEN	16.15	14.55
82207	POLYESTER THREAD, 4OZ. BLACK	16.15	14.55
82209	POLYESTER THREAD, 4OZ. ROYAL BLUE	16.15	14.55
82210	POLYESTER THREAD, 4OZ. NAVY	16.15	14.55
82214	POLYESTER THREAD, 4OZ. STEEL GRAY	16.15	14.55

STOCK No.	POLYESTER THREAD 1 LB./4800 YARD CONES	PER CONE	LOT OF 6, PER CONE
82216	POLYESTER THREAD, 1 LB./4800 YARD CONE BLACK	\$48.95	\$44.05
82217	POLYESTER THREAD, 1 LB./4800 YARD CONE NATURAL	39.95	35.95
82218	POLYESTER THREAD, 1 LB./4800 YARD CONE BEAVER	48.95	44.05

POLYESTER BOBBINS

1/2 GROSS BOX, SIZE 92

STOCK No.	"G" STYLE BOBBINS	1/2 GROSS PKG EACH	2 PKGS OR MORE EACH
82220	STYLE "G" BOBBINS BEAVER	\$43.50	\$39.15
82221	STYLE "G" BOBBINS WHITE	35.25	31.75
82222	STYLE "G" BOBBINS BLACK	43.50	39.15
STOCK No.	"M" STYLE BOBBINS	1/2 GROSS PKG EACH	2 PKGS OR MORE EACH
82229	STYLE "M" BOBBINS WHITE	\$44.25	\$39.95
82230	STYLE "M" BOBBINS BEAVER	43.50	39.25
82231	STYLE "M" BOBBINS BLACK	43.50	39.25



STYLE G BOBBINS FOR USE IN:

SINGER 110-W, 111-2, JUKI 562, PHAFF 145 MACHINES.

STYLE M BOBBINS (SAME AS J BOBBINS) FOR USE IN:

CONSO 20RB, PHAFF 545, 1245, SINGER 144W, 145W MACHINES

~ NYLON THREAD & BOBBINS ~

B-69 NYLON THREAD

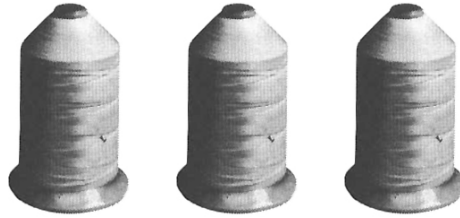

Stock No.	4oz./1500 Yd TUBES	EACH	BOX OF 4 TUBES/EACH
80174	B-69 NYLON THREAD TEAL	\$10.95	\$9.95
80175	B-69 NYLON THREAD OLIVE DRAB	10.95	9.95
80176	B-69 NYLON THREAD SCARLET	10.95	9.95
80177	B-69 NYLON THREAD LIGHT BROWN	10.95	9.95
80178	B-69 NYLON THREAD DARK GREEN	10.95	9.95
80179	B-69 NYLON THREAD DARK GREY	10.95	9.95
80180	B-69 NYLON THREAD WEDGEWOOD/LIGHT BLUE	10.95	9.95
80181	B-69 NYLON THREAD BEAVER	10.95	9.95
80182	B-69 NYLON THREAD DARK CARDINAL/BURGUNDY	10.95	9.95
80183	B-69 NYLON THREAD BEIGE	10.95	9.95
80184	B-69 NYLON THREAD WHITE	10.95	9.95
80185	B-69 NYLON THREAD MEDIUM BROWN	10.95	9.95
80186	B-69 NYLON THREAD EMERALD	10.95	9.95
80187	B-69 NYLON THREAD BLACK	10.95	9.95
80188	B-69 NYLON THREAD GOLD	10.95	9.95
80189	B-69 NYLON THREAD STEEL GREY	10.95	9.95
80190	B-69 NYLON THREAD NAVY	10.95	9.95
80191	B-69 NYLON THREAD RUST/TOBOGGAN	10.95	9.95
80192	B-69 NYLON THREAD ROSE	10.95	9.95
80193	B-69 NYLON THREAD CHESTNUT	10.95	9.95
80194	B-69 NYLON THREAD SAGE (COLOR DISCONTINUED??)	10.95	9.95
80197	B-69 NYLON THREAD NATURAL	10.95	9.95
80198	B-69 NYLON THREAD ROYAL	10.95	9.95

NYLON BOBBINS

1/2 GROSS PKG/BOXES

Stock No.	"G" STYLE NYLON BOBBINS	1/2 GROSS PKG EACH	2 PKGS OR MORE EACH
80203	"G" STYLE B-69 BOBBINS BEIGE	\$37.75	\$33.95
80204	"G" STYLE B-69 BOBBINS WHITE	33.75	30.50
80205	"G" STYLE B-69 BOBBINS BROWN	37.75	33.95
80207	"G" STYLE B-69 BOBBINS BLACK	37.75	33.95
	"A" STYLE NYLON BOBBINS	1/2 GROSS PKG EACH	
80216	"A" STYLE B-69 BOBBINS WHITE	\$37.25	
80217	"A" STYLE B-69 BOBBINS BLACK	41.95	



STYLE G BOBBINS FOR USE IN:
SINGER 110-W, 111-2, JUKI 562, PHAFF 145 MACHINES.

STYLE A BOBBINS FOR USE IN:
SINGER 16-188, 31-15, 78-3, REX 26-188 MACHINES.

~ MONOFILAMENT THREAD & BOBBINS ~

MONOFILAMENT THREAD

CLEAR, SINGLE STRAND

STOCK No.		PER CAN	5 CANS, PER CAN
60158	No. 9 SIZE 24/4 1.4 TO 1.6 LB. PER CAN	\$34.95	\$31.45
60159	No. 11 SIZE 16/4 1.4 TO 1.6 LB. PER CAN	35.50	31.95



MONOFILAMENT BOBBINS

CLEAR, 50 PER BOX

STOCK No.		PER BOX
80196	"G" STYLE MONOFILAMENT BOBBINS	\$11.95

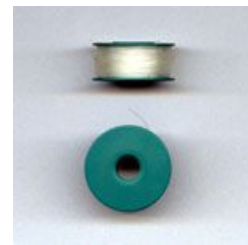

CONTACT **MOSEHART-SCHLEETER**
FOR ALL OF YOUR VINYL AND FAUX LEATHER NEEDS.

UNIROYAL ~ OMNOVA ~ SPRADLING ~ NASSIMI ~ MORBERN
~ NAUGAHYDE ~ BOLTAFLEX ~ SYMPHONY ~

LARGE SELECTION OF PATTERNS AND COLORS

SIZEABLE YARDAGE CARRIED IN STOCK ON THE MOST POPULAR PATTERNS AND COLORS

SEE OUR VINYL SAMPLE BOOKS FOR PRICING OR CALL US FOR INFORMATION

~ HAND STITCHING THREAD ~ BUTTON TWINE ~ SPRING TWINE ~

NYLON HAND STITCHING THREAD

APPROX. 2 Oz. TUBE

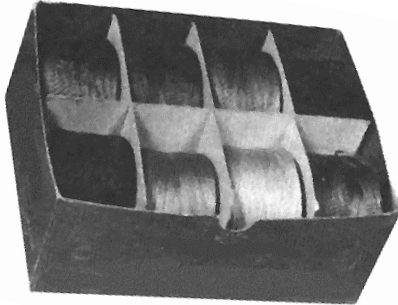

STOCK No.		PER TUBE, EACH	8 TUBES, EACH
80232	NYLON #18 WHITE	\$7.50	\$6.75
80234	NYLON #18 BLUE	7.50	6.75
80235	NYLON #18 OLIVE	7.50	6.75
80236	NYLON #18 RED	7.50	6.75
80237	NYLON #18 BEAVER	7.50	6.75
80238	NYLON #18 BROWN	7.50	6.75
80239	NYLON #18 BLACK	7.50	6.75
80240	NYLON #18 BEIGE	7.50	6.75

NYLON BUTTON TWINE

100% NYLON, 1050 FT PER BOX



STOCK No.		PER BOX	5 BOXES, PER BOX
60131	GOLDEN NYLON TUFTING TWINE	\$13.95	\$12.75

JUTE SPRING TWINE



STOCK No.		EACH	5 BALLS, EACH
60135	1-LB BALL RUBY SPRING TWINE	\$23.75	\$21.50

~ GLUE GUN ~ ADHESIVE ~ GLUE STICKS ~

AIR SPRAY GLUE SYSTEM

LOW PROFILE ALUMINUM JAR
 SYPHON TYPE EXTERNAL MIX
 STRONGER LIQUID NOZZLE
 WORKS WITH ANY AIR COMPRESSOR



STOCK No.		EACH
60182	All Spray Glue Gun	\$32.50
60500	Plastic Jar	3.95
60184	Gasket for Aluminum Jar	2.50

FAST TACK ADHESIVE

(NON-FLAMMABLE)

FOR USE ON FOAM, FABRIC, OR SUPPORTED VINYL.
 IDEAL FOR GLUING PANEL FABRICS.

WARNING: CONTAINS METHYLENE CHLORIDE
 WHICH HAS BEEN SHOWN TO CAUSE CANCER IN
 CERTAIN ANIMALS UNDER LABORATORY CONDITIONS.

STOCK No.	1 GAL. PAIL	EACH	4 GAL., EACH
61313	313B RED FAST TACK ADHESIVE	\$42.95	\$38.65
61314	313B CLEAR FAST TACK ADHESIVE	42.95	38.65
	5 GAL. PAIL	EACH	5 OR MORE 5 GAL PAILS
61315	313B CLEAR FAST TACK ADHESIVE	\$212.50	\$191.25



4 GALLONS PER CASE

**5 GAL PAILS CAN NOT BE SHIPPED UPS OR FEDEX.
 MUST BE SHIPPED VIA TRUCKLINE, AND A HAZARDOUS SHIPPING CHARGE MAY APPLY.**

GLUE STICKS



STOCK No.		PER BOX	5 BOXES, PER BOX
60493	1/2" DIAMETER GLUE STICKS FOR OSBORNE 2001 GLUE GUN, BOX OF 12	\$9.95	\$8.95

STOCK No.		PER LB.	5 LBS., PER LB.
60491	5/8" DIAMETER HOT MELT GLUE STICKS FOR TC POLY GUN	\$14.50	\$13.05

~ SILICONE SPRAY ~

DRY SILICONE LUBRICANT SPRAY

- GENERAL PURPOSE LUBRICANT DRY SPRAY PATTERN
- NON BLEED THROUGH OR STAINING
- DOES NOT CONTAIN OZONE DEPLETING CHEMICALS OR METHYLENE CHLORIDE
- COMPLIES WITH FDA REGULATIONS

Stock No.		EACH	12+ CANS , EACH
60201	DRY SILICONE LUBRICANT SPRAY	\$8.95	\$7.95



NET WT. 13 oz

NOTE: DUE TO REGULATIONS, AEROSOL CANS MUST BE SHIPPED IN A CORRUGATED BOX AND CAN NOT BE SHIPPED BY AIR

3M™ SILICONE LUBRICANT SPRAY

- FAST DRYING
- CONTAINS NO PETROLEUM OILS
- HELPS PREVENT RUST AND CORROSION
- NON-STAINING
- REPELS WATER
- HIGH TEMPERATURE RESISTANCE

Stock No.		EACH	12+ CANS, EACH
60200	3M™ SPRAY SILICONE	\$20.95	\$18.95

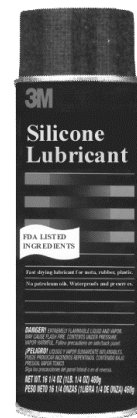

NET WT. 13.2 oz

NOTE: DUE TO REGULATIONS, AEROSOL CANS MUST BE SHIPPED IN A CORRUGATED BOX AND CAN NOT BE SHIPPED BY AIR

~ HI-STRENGTH/HIGH TEMPERATURE ADHESIVE SPRAY & TUBE GLUE ~

3M™ HI-STRENGTH 90 ADHESIVE SPRAY

No. 90 IS AN EXTRA STRONG, FAST BONDING SPRAY ADHESIVE WITH ADJUSTABLE, CONTROLLED SPRAY. FAST TACK WORKS HARD TO BOND MATERIALS SUCH AS LIGHT WEIGHT METALS, WOOD AND GLASS. SECURELY BONDS FABRIC AND FOAM TO WOOD OR METAL.

Stock No.		EACH	12+ CANS, EACH
60183	No. 90 SPRAY ADHESIVE	\$34.95	\$31.45



NOTE: DUE TO REGULATIONS, AEROSOL CANS MUST BE SHIPPED IN A CORRIGATED BOX AND CAN NOT BE SHIPPED BY AIR.

NET WT. 17.6 oz

CAMIE #393 SPRAY ADHESIVE

HIGH STRENGTH, HIGH TEMPERATURE, WATER RESISTANT, CLEAR NON-YELLOWING. FOR HEADLINER, TRIM & DECORATIVE LAMINATE WORK, FURNITURE, CABINETS OR WOODWORKING.

Stock No.		EACH	12+ CANS,, EACH
61393	CAMIE #393 SPRAY ADHESIVE	\$15.95	14.35



NOTE: DUE TO REGULATIONS, AEROSOL CANS MUST BE SHIPPED IN A CORRIGATED BOX AND CAN NOT BE SHIPPED BY AIR.

NET WT. 12.5 oz

M-S SPECIAL ADHESIVE

STRONG, INEXPENSIVE, AND EASY TO USE

OUR INDUSTRIAL STRENGTH FOAM AND FABRIC ADHESIVE CAN BE USED ON FOAM RUBBER, BONDED DACRON, CLOTH, WOOD, CARDBOARD, PAPER, SUPPORTED VINYL, AND PLASTIC. THIS ADHESIVE YIELDS EASY, FAST, CLEAN, PROFESSIONAL RESULTS.

Stock No.		EACH	12+ CANS, EACH
60202	SPECIAL ADHESIVE	\$8.95	\$8.05

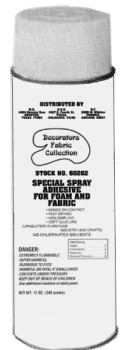

NOTE: DUE TO REGULATIONS, AEROSOL CANS MUST BE SHIPPED IN A CORRIGATED BOX AND CAN NOT BE SHIPPED BY AIR.

NET WT. 12 oz.

3M™ SCOTCH-GRIP 4475 PLASTIC ADHESIVE

DESIGNED TO BOND VINYL AND PLASTICS TO THEMSELVES OR TO OTHER MATERIALS SUCH AS WOOD AND METAL. CLEAR, FAST TACKING AND DRIES QUICKLY TO A FIRM BOND. RESISTS WATER, DETERGENT, GREASE AND OILS.

Stock No.		EACH	LOT OF 6, EACH
28072	3M™ 4475 PLASTIC ADHESIVE	\$20.95	\$18.95



~ LEGS ~ LEG PLATES ~ T-NUTS ~ GLIDES ~

ROUND LEGS

LEGS CAN BE CUT IF A SHORTER LEG IS NEEDED.

UNFINISHED WOOD LEGS
5/16" HANGER BOLT



LEG PLATES SOLD SEPARATELY

STOCK NO.		EACH	12 OR MORE, EACH
60208	4" ROUND LEGS	\$7.50	\$6.75
60209	5" ROUND LEGS	7.50	\$6.75

LAWSON LEGS

UNFINISHED WOOD LEGS
5/16" HANGER BOLT



LEG PLATES SOLD SEPARATELY

STOCK NO.		EACH	12 OR MORE, EACH
60215	6" LAWSON LEGS	\$7.50	\$6.75
60216	4" LAWSON LEGS	7.50	6.75

LEG PLATES

FLAT WITH 5/16" HOLE TO FIT ABOVE LEGS

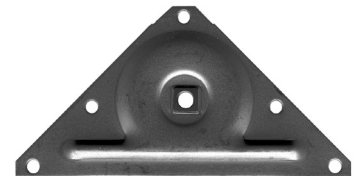

STOCK NO.		EACH	12 OR MORE, EACH
60217	FLAT LEG PLATES	\$1.50	\$1.35

QUEEN ANNE LEGS

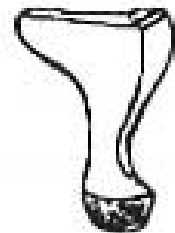

STOCK NO		EACH	12 OR MORE, EACH
60211	5" QUEEN ANNE CORNER LEGS	\$19.50	\$17.55
60212	5" QUEEN ANNE CENTER LEGS	19.50	17.55
60213	6" QUEEN ANNE CORNER LEGS	19.50	17.55
60214	6" QUEEN ANNE CENTER LEGS	19.50	17.55

T-NUTS

APPROXIMATELY 100 PER PACKAGE



STOCK NO.		PER PACKAGE	5 PACKAGES, EACH
61211	5/16" THREAD, 5/8" BARREL	9.95	8.95
61212	1/4" THREAD, 7/16" BARREL	9.95	8.95

POLISHED GLIDES

STOCK NO.		PACKAGE OF 100
60072	5/8" 3 PRONG GLIDES	\$7.95
60073	3/4" 3 PRONG GLIDES	12.50
60074	7/8" CENTER PRONG GLIDES	18.95



3 PRONG GLIDE



CENTER PRONG GLIDE

~ CASTERS ~

SHEPHERD PLANET
2 1/2" METAL CASTERS

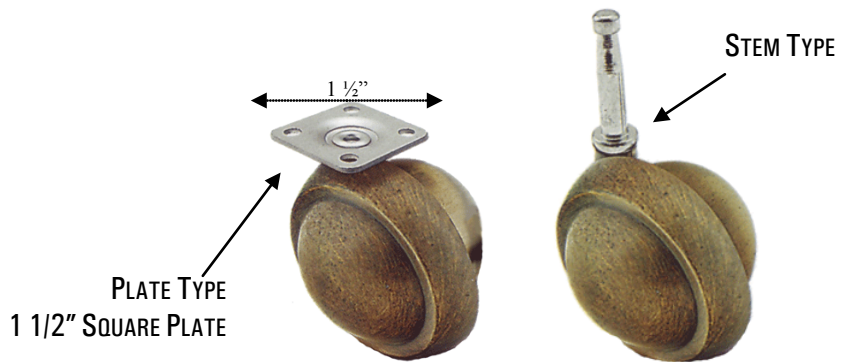

STOCK No.	SHEPHERD PLANET 2 1/2" METAL CASTERS	EACH	12 OR MORE, EACH
60186	P1-WA WINDSOR ANTIQUE PLATE TYPE	\$8.50	\$7.65
60188	P1-BB BRIGHT BRASS PLATE TYPE	8.50	7.65
60189	P2-WA WINDSOR ANTIQUE STEM TYPE	8.50	7.65
60191	P2-BB BRIGHT BRASS STEM TYPE	8.50	7.65

SHEPHERD SATELLITE
2" METAL CASTERS

STOCK No.	SHEPHERD SATELLITE 2" METAL CASTERS	EACH	12 OR MORE, EACH
60192	SE1-WA WINDSOR ANTIQUE PLATE TYPE	\$6.50	\$5.85
60194	SE1-BB BRIGHT BRASS PLATE TYPE	6.50	5.85
60195	SE2-WA WINDSOR ANTIQUE STEM TYPE	6.50	5.85
60197	SE2-BB BRIGHT BRASS STEM TYPE	6.50	5.85

DUAL WHEEL PACER CASTER

DUAL NYLON WHEELS PLACE MORE OF THE WHEEL ON CARPET FOR BETTER TRACTION AND MOBILITY.

2 3/8" DIAMETER
WINDSOR ANTIQUE FINISH,
BLACK WHEELS

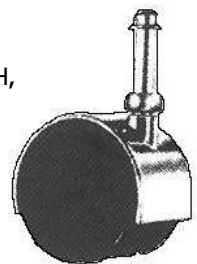

STOCK No.		EACH	12 OR MORE, EACH
60193	DUAL WHEEL CASTER PLATE TYPE	\$7.95	\$7.25
60196	DUAL WHEEL CASTER STEM TYPE	7.95	7.25

CASTER SLEEVES

SLEEVE
FOR WOOD FURNITURE

STOCK No.		EACH	12 OR MORE, EACH
64120	METAL SLEEVE FOR STEM CASTERS	\$.75	\$.70





~ PLIER STAPLER ~ REPLACEMENT PARTS FOR TACKERS ~ TOOL OIL ~

BOSTITCH STAPLING PLIER
& STAPLES

STOCK No.		EACH	
70130	P6C-6 BOSTITCH HAND STAPLING PLIER	\$56.95	
	STAPLES FOR P6C-6 STAPLING PLIER	PER BOX	5 BOXES OR MORE
70131	STCR-2619 1/4" STAPLES 5,000 PER BOX	\$4.50	\$4.00
70132	STCR-2619 3/8" STAPLES 5,000 PER BOX	5.00	4.50



STOCK No.		EACH
70113	 25 FT. RECOIL HOSE	\$12.95
70111	 12 INCH WHIP END	\$16.95

STOCK No.		EACH
70112	 QUICK CHANGE FEMALE COUPLER	\$10.95
70116	 QUICK CHANGE MALE PLUG	\$6.95



PNEUMATIC TOOL
OIL

STOCK No.		EACH
82274	PNEUMATIC TOOL OIL – 8 Oz.	\$7.50



DAILY USE IS RECOMMENDED TO CONDITION SEALS AND INSURE PROPER FUNCTION OF AIR STAPLERS.
USE TWO DROPS WHERE HOSE ATTACHES TO STAPLER.

~ DUO-FAST STAPLERS ~ STAPLES ~



TI-3118 SURESHOT AIR STAPLER
STOCK No. 70104
\$250.00 EACH.

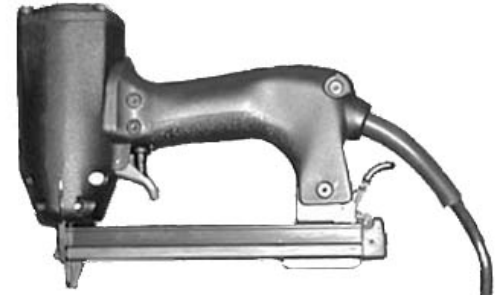
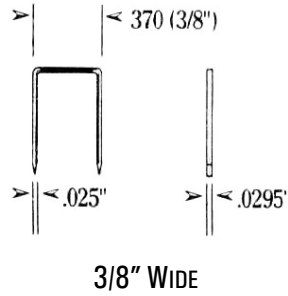

EIC 3118A ELECTRIC STAPLER
STOCK No. 70109
\$350.00 EACH.

STOCK No.	STAPLES FOR SURESHOT TI-3118 / EIC-3118A	PER BOX	CASE, PER BOX	BOXES PER CASE
73108	No. 3108 1 4" 23,300 STAPLES	\$29.50	\$26.55	12
73112	No. 3112 3/8" 16,700 STAPLES	20.50	18.45	12
73116	No. 3116 1/2" 13,360 STAPLES	21.00	18.90	12
73118	No. 3118 9/16" 13,360 STAPLES	14.50	13.05	10
95531	No. 3112 3/8" 10,000 <i>STAINLESS STEEL</i> STAPLES	50.75	45.75	20

STOCK No.	STAPLES FOR SURE SHOT 5020 / AWC-5018 AIR OR EWB-5018 ELECTRIC STAPLERS	PER BOX	CASE, PER BOX	BOXES PER CASE
70508	No. 508 1/4" 5000 PER BOX - STAPLE WIDTH 1/2" WIDE	\$6.95	\$6.25	20
75010	No. 5010 5/16" 5000 PER BOX - STAPLE WIDTH 1/2" WIDE	6.95	6.25	20
75012	No. 5012 3/8" 5000 PER BOX - STAPLE WIDTH 1/2" WIDE	13.25	11.95	20
75016	No. 5016 1/2" 5000 PER BOX - STAPLE WIDTH 1/2" WIDE	8.95	8.05	20
75018	No. 5018 9/16" 5000 PER BOX - STAPLE WIDTH 1/2" WIDE	8.95	8.05	20
95530	No. 5012 3/8" 5000 <i>STAINLESS STEEL</i> STAPLES	37.95	34.15	20

THE DUO-FAST SURESHOT 5020 AIR AND EWB 5018 ELECTRIC WIDE CROWN STAPLERS ARE AVAILABLE.

CALL US FOR PRICING AND AVAILABILITY.

THE SURESHOT 5020 AIR STAPLER REPLACES THE AWC 5018 STAPLER AND DRIVES THE SAME STAPLE.

STOCK No.	STAPLES FOR DUO-FAST AIC-3318 AIR STAPLER (MED) & EIB-3318 ELECTRIC STAPLER (MED)	PER BOX	CASE, PER BOX	BOXES PER CASE
70338	No. 338-3308 1/4" STAPLES 10,000 PER BOX - STAPLE WIDTH 3/8" WIDE	\$6.95	\$6.25	20
73312	No. 3312 3/8" STAPLES 10,000 PER BOX - STAPLE WIDTH 3/8" WIDE	9.50	8.55	20
73316	No. 3316 1/2" STAPLES 10,000 PER BOX - STAPLE WIDTH 3/8" WIDE	9.50	8.55	20
73318	No. 3318 9/16" STAPLES 10,000 PER BOX - STAPLE WIDTH 3/8" WIDE	9.50	8.55	20

STOCK No.	STAPLES FOR DUO-FAST 3012 SERIES	PER BOX	CASE, PER BOX	BOXES PER CASE
70308	No. 308 1/4" STAPLES 5,000 PER BOX	\$13.50	\$12.15	20
73010	No. 3010 5/16" STAPLES 5,000 PER BOX	13.50	12.15	20

~ EMPIRE / RAINCO STAPLERS ~ STAPLES ~ O-RING KITS ~



**RAINCO LONG NOSE
AIR STAPLER**

THESE STAPLERS ARE OFTEN LABELED
"RAINCO"
BUT ARE THE SAME AS THE WELL KNOWN
EMPIRE STAPLERS.



**RAINCO STANDARD
AIR STAPLER**

STOCK No.		EACH
82275	#7 RAINCO 2" LONG NOSE AIR STAPLER	\$230.00
82277	#7 RAINCO 1" STANDARD AIR STAPLER	170.00

#7 STAPLES

FOR USE IN THE EMPIRE/RAINCO ABOVE AND TC-08 BELOW

STOCK No.	10,000 PER BOX	PER BOX	CASE, PER BOX	BOXES PER CASE
82280	#7 1/4" STAPLES - STAPLE WIDTH 3/8" WIDE	\$7.50	\$6.75	20
82281	#7 3/8" STAPLES - STAPLE WIDTH 3/8" WIDE	8.50	7.65	20
82282	#7 1/2" STAPLES - STAPLE WIDTH 3/8" WIDE	8.95	8.05	20
95532	#7 3/8" STAINLESS STEEL STAPLES	29.95	26.95	20

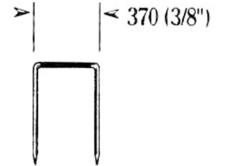

TC-08 AIR STAPLER

THIS IS AN INEXPENSIVE, MEDIUM DUTY STAPLER.
USES #7 STAPLES.

STOCK No.		EACH
82279	TC-08 AIR STAPLER, 3/4" NOSE	\$69.00



O-RING KITS

STOCK No.		EACH
70255	O RING KIT FOR OLD #7 EMPIRE	\$15.25
70256	O RING KIT FOR NEW #7 RAINCO	\$15.25

~ TRIM / SNAP FASTENERS ~

SNAP FASTENERS

NICKEL PLATED BRASS – SCREW PORTION OF SCREW IS STAINLESS STEEL
RUST-RESISTANT

FOR ASSEMBLING FASTENERS
 CLOTH TO CLOTH, YOU WILL NEED THE
 FOLLOWING FOUR PARTS:
 BUTTON CAP – SOCKET – STUD – EYELET

STOCK No.	CAPS	BOX OF 100	10+ BOXES, PER BOX
93628	VL-10128 BUTTON CAP (SHORT)	\$14.40	\$12.95
93629	VL-10127 BUTTON CAP (LONG)	16.45	14.80
	SOCKETS		
93630	VL-10224 SOCKET	12.95	11.65
	STUDS		
93631	VL-10370 STUD	8.50	7.65
	EYELETS		
93632	VL-10412 EYELET (SHORT)	7.95	7.15
93633	VL-10413 EYELET (LONG)	7.95	7.15
	SCREWS		
93635	VL-10393-12 SHORT SCREW 3/8"	35.25	31.75
93637	VL-10393-20 LONG SCREW 5/8"	35.25	31.75



BUTTON CAP



SOCKET



STUD



EYELET



SCREW

OTHER TRIM FASTENERS ARE AVAILABLE ON A SPECIAL ORDER BASIS.

MILITARY BLACK OR STAINLESS STEEL

PLEASE CALL US FOR PRICING AND AVAILABILITY

#30 SNAP

BUTTONS

100 PER PACKAGE

FOR USE WITH #30 BUTTON CAPS
 ALLOWS YOU TO MAKE A COVERED
 SNAP BUTTON

TO MATCH FABRIC OR VINYL



STOCK No.		PER PACKAGE	5+ PKGS, PER PACKAGE
93643	#30 SNAP BUTTONS	\$8.95	\$8.05

~ STEAMERS ~

MODEL J-2
STEAMER

1 GALLON CAPACITY
1300 WATT HEATING ELEMENT AT 120 VOLTS
DUAL THERMOSTATS FOR STEAM IN JUST 2 MINUTES!



STOCK No.		EACH
60284	J-2 STEAMER WITH 5 1/2 FT HOSE	\$230.00
60280	ROCKER SWITCH W/ LIGHT (20B) FOR J-2 STEAMER	16.95
60281	TOGGLE SWITCH (20A) FOR J-2 STEAMER	12.95
60286	5 1/2 FT HOSE WITH ATTACHMENT	80.00
60287	HEATING ELEMENT FOR J-2 STEAMER	130.25
60469	1 GALLON PLASTIC JUG FOR J-2 STEAMER	15.95
64290	L290 THERMOSTAT (NEW TYPE FOR J-2 STEAMER)	13.95

MODEL J-4000
PROFESSIONAL/COMMERCIAL STEAMER

HEAVIER DUTY STEAMER THAN THE J-2 FOR THOSE THAT USE A STEAMER ON A MORE REGULAR BASIS.

1500 WATT HEATING ELEMENT AT 120 VOLTS
CORROSION – PROOF INTERNAL STAINLESS STEEL BOILER TANK

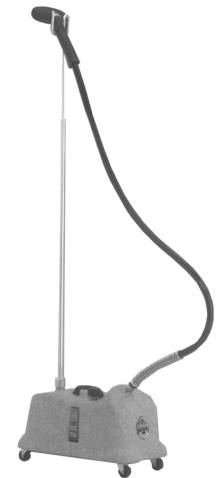

STOCK No.		EACH
60460	J-4000 STEAMER WITH 7 1/2 FT HOSE	\$340.00
60462	HEATING ELEMENT FOR J-4000 STEAMER	50.95
60286	5 1/2 FT HOSE WITH ATTACHMENT	80.00
60464	7 1/2 FT HOSE WITH ATTACHMENT	106.50
60474	L-170 THERMOSTAT FOR J-4000 STEAMER	16.00
60466	SWITCH AND KNOB FOR J-4000 STEAMER	22.50
60467	WATER LEVEL DIPSTICK	5.95

~ SHEARS ~ PIPING TINS ~

WISS® SHEARS

BENT TRIMMERS
FORGED CARBON STEEL WITH
NICKEL CHROME PLATING



STOCK No.		EACH	6 OR MORE, EACH
60272	8" WISS® SHEARS	\$38.95	\$35.25
60274	10" WISS® SHEARS	50.75	45.75
60276	12" WISS® SHEARS	56.25	50.75
60275	10" LEFT HAND SHEARS	54.95	49.50
60277	10" KNIFE EDGE SHEARS	69.25	62.50
60278	12" KNIFE EDGE SHEARS	63.95	57.75

WISS® SNIP SHEARS



STOCK No.		EACH	6 OR MORE, EACH
60279	8" SNIP SHEARS	\$36.25	\$32.75



PIPING TINS

3" x 36" LONG, SOLD BY THE PAIR

STOCK No.		PER PAIR
60306	#412-3 PIPING TINS	\$36.95



~ TOOL KITS & INSTRUCTION ~

PROFESSIONAL UPHOLSTERY TOOL KIT

THIS ALL-INCLUSIVE KIT FILLS THE NEEDS OF THE JOURNEYMAN UPHOLSTERER, TRAINEE, OR THE AMBITIOUS AMATEUR. IT CONTAINS 14 TOP QUALITY C.S. OSBORNE TOOLS AND NEEDLES AS WELL AS A FREE INSTRUCTION BOOK.

THE PROFESSIONAL UPHOLSTERY TOOL KIT CONTAINS:

- | | |
|------------------------------------|-----------------------------|
| 1 - No. 33 BRONZE MAGNETIC HAMMER | 1 - No. 396-2 RUBBER MALLET |
| 1 - No. 253 STRETCHER | 1 - No. 684 10 10" SHEARS |
| 1 - No. 120 1/2 STAPLE LIFTER | 1 - K-3 NEEDLE CARD |
| 1 - No. 402 RIPPING CHISEL | 1 - K-5 NEEDLE CARD |
| 1 - No. 76 1/2" KNIFE | 36 - 3" UPHOLSTERY PINS |
| 1 - No. 306 1/2 8" LIGHT REGULATOR | 1 - BOX WHITE TAILOR CHALK |
| | 1 - INSTRUCTION BOOK |



Stock No.		EACH	6 OR MORE KITS, EACH
60289	PROFESSIONAL UPHOLSTERY TOOL KIT	\$160.00	\$144.00

BEGINNERS UPHOLSTERY TOOL KIT

THIS KIT CONTAINS THE BASIC TOOLS AND NEEDLES REQUIRED FOR QUALITY UPHOLSTERY WORK. THIS IS THE KIT CHOSEN BY MANY SCHOOLS AND INSTITUTIONS TO TEACH THE BASICS OF THE UPHOLSTERY TRADE.

THE BEGINNERS UPHOLSTERY TOOL KIT CONTAINS:

- | | |
|---|----------------------------------|
| 1 - No. 222-C TACK HAMMER | 1 - No. 501 1/2 3" CURVED NEEDLE |
| 1 - No. 253 GOOSENECK WEBBING STRETCHER | 1 - No. 501 1/2 4" CURVED NEEDLE |
| 1 - No. 120 1/2 STAPLE LIFTER | 1 - No. 501 1/2 6" CURVED NEEDLE |
| 1 - No. 402 RIPPING CHISEL | 1 - No. 502 1/2 4" CURVED NEEDLE |
| 1 - No. 76 1/2 SQUARE POINT KNIFE | 1 - No. 504-8 8" STRAIGHT NEEDLE |
| 1 - No. 520-8 REGULATOR W/ PLASTIC HANDLE | 1 - No. 684 10" SHEARS |
| 36 - 3" UPHOLSTERY PINS | 1 - BOX - TAILOR CHALK |
| | 1 - INSTRUCTION BOOK |



Stock No.		EACH	6 OR MORE KITS, EACH
60301	BEGINNER'S UPHOLSTERY TOOL KIT	\$130.00	\$117.00

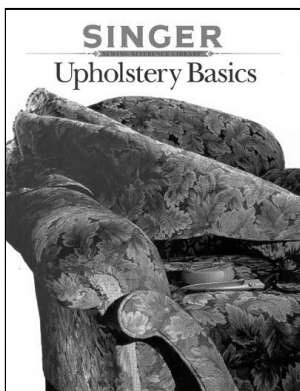

UPHOLSTERY TEXT BOOK

THIS BOOK CONTAINS 125 PAGES OF INSTRUCTIONS ALONG WITH FULL COLOR PHOTOGRAPHS TO HELP YOU GET STARTED IN THE UPHOLSTERY TRADE. A PART OF THE SINGER REFERENCE LIBRARY, THIS BOOK IS USED BY MANY VOCATIONAL SCHOOLS TO SUPPLEMENT IN CLASS TEACHING. ANYONE INTERESTED IN UPHOLSTERY SHOULD BUY THIS BOOK TO LEARN NEW METHODS OR PERFECT OLD ONES.

Stock No.		EACH
61230	UPHOLSTERY BASICS TEXTBOOK	\$20.95

~ UPHOLSTERY TOOLS ~

PIN REMOVER & RESETTER

FOR USE WITH LA-Z-BOY CHAIR



THIS TOOL DOES THE COMPLETE JOB. PERMITS EASY ACCESS TO RETAINING KEY PIN. ONE SHOT IN AND OUT REMOVES AND RESETS PINS.

Stock No.		EACH
60580	#96 PIN REMOVER AND RESETTER	\$37.95

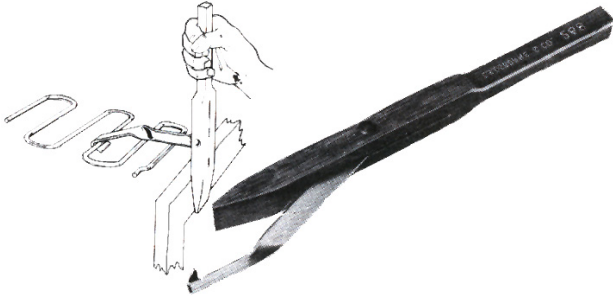

Stock No.		EACH
60586	#268 LEVER SPRING STRETCHER	\$36.50

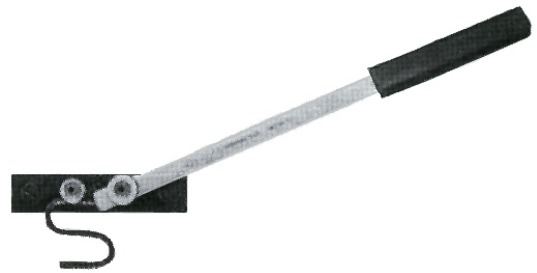

Stock No.		EACH
60590	#404 SPRING END FORMER	\$54.95

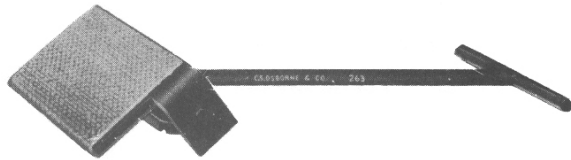

Stock No.		EACH
60584	RUBBER WEBBING STRETCHER	\$48.95

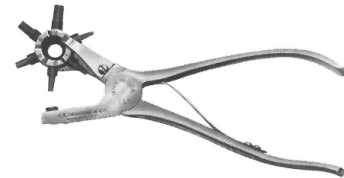

Stock No.		EACH
60581	#223 REVOLVING PUNCH	\$18.95

TUFTING NEEDLE

Stock No.		EACH
60593	#417 HOLLOW TUFTING NEEDLE	\$42.95
60594	#418 TUFTING CLASPS (500 PER BOX)	18.95

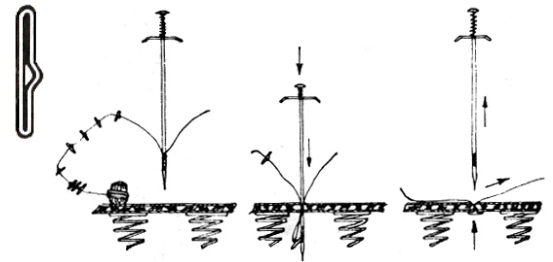

BUTTON TUFTER

Stock No.		EACH
60314	#613 BUTTON TUFTER W/ 24 CLIPS	\$20.95
60315	ADDITIONAL 1 GROSS TUFTER CLIPS	10.95

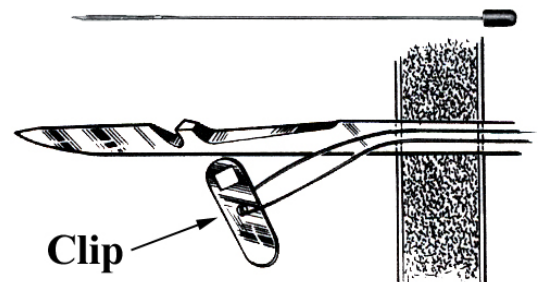

~ HAMMERS & MALLETS ~

MAGNETIC HAMMERS

STOCK No.		EACH	6 OR MORE, EACH
60309	7oz. HEAD MAGNETIC HAMMER	\$39.95	\$35.95
60310	9oz. HEAD MAGNETIC HAMMER	44.50	40.00



THIS HAMMER IS SIMILAR TO THE BRONZE MAGNETIC HAMMERS LISTED ABOVE, BUT THE LARGE END IS FITTED WITH A NYLON TIP. THIS PREVENTS DAMAGE TO ORNAMENTAL NAILS.

STOCK No.		EACH	6 OR MORE, EACH
60318	7oz. HEAD FITTED WITH NYLON TIP	\$44.25	\$39.85
60311	REPLACEMENT NYLON TIP FOR HAMMER	5.95	5.35

STRIPPING HAMMER

STOCK No.		EACH	6 OR MORE, EACH
60316	#277.5 STRIPPING HAMMER	\$51.95	\$46.75



RUBBER MALLET

STOCK No.		EACH	6 OR MORE, EACH
60319	#197.2 12oz. RUBBER MALLET	\$13.95	\$12.55

RAWHIDE MALLET

STOCK No.		EACH	6 OR MORE, EACH
60582	#196 9oz. RAWHIDE MALLET	\$51.95	\$46.50



HAMMER HANDLE

STOCK No.		EACH	6 OR MORE, EACH
60313	HICKORY HAMMER HANDLE	\$4.75	\$4.25

~ WEBBING STRETCHERS ~ CHISELS ~ STAPLE PULLERS ~ AWLS ~

Stock No		EACH	
60305	#255 WEBBING STRETCHER	\$17.50	
60321	GOOSENECK WEBBING STRETCHER	35.10	
60322	# 402.5 RIPPING CHISEL / TACK LIFTER	17.95	
60327	#120.5 STAPLE REMOVER	23.50	
60324	#201 TACK LIFTER	21.75	
60325	#402 RIPPING CHISEL	17.95	
60299	BEST STAPLE PULLER MADE BERRY STAPLE PULLER (WOODEN HANDLE)	18.95	
60721	#121 TACK & STAPLE REMOVER	23.50	
60530	#15 WEBBING STRETCHER	24.90	
60595	#4 AWLS	11.25	

~ NEEDLES ~

STRAIGHT NEEDLES

STOCK No.	SINGLE ROUND POINT NEEDLES	EACH	12 OR MORE, EACH
60340	6" STRAIGHT SINGLE ROUND POINT	\$2.50	\$2.25
60342	8" STRAIGHT SINGLE ROUND POINT	2.75	2.50
60343	10" STRAIGHT SINGLE ROUND POINT	4.00	3.75
60344	12" STRAIGHT SINGLE ROUND POINT	4.25	4.00
60345	14" STRAIGHT SINGLE ROUND POINT	5.00	4.50
	SINGLE 3 SQUARE POINT NEEDLES		
60351	6" STRAIGHT SINGLE 3 SQUARE POINT	\$3.50	\$3.25
60352	8" STRAIGHT SINGLE 3 SQUARE POINT	4.00	3.75
60353	10" STRAIGHT SINGLE 3 SQUARE POINT	6.25	5.75
60354	12" STRAIGHT SINGLE 3 SQUARE POINT	6.75	6.25
60355	14" STRAIGHT SINGLE 3 SQUARE POINT	7.50	6.75
	DOUBLE ROUND POINT NEEDLES		
60361	8" STRAIGHT DOUBLE ROUND POINT	\$3.25	\$3.00
60362	10" STRAIGHT DOUBLE ROUND POINT	4.25	4.00
60363	12" STRAIGHT DOUBLE ROUND POINT	4.75	4.50
60364	14" STRAIGHT DOUBLE ROUND POINT	5.50	5.00
	DOUBLE 3 SQUARE POINT NEEDLES		
60369	8" STRAIGHT DOUBLE 3 SQUARE POINT	\$4.75	\$4.50
60370	10" STRAIGHT DOUBLE 3 SQUARE POINT	6.75	6.25
60371	12" STRAIGHT DOUBLE 3 SQUARE POINT	7.50	6.75
60372	14" STRAIGHT DOUBLE 3 SQUARE POINT	8.50	7.65



CURVED NEEDLES

STOCK No.	ROUND POINT NEEDLES	EACH	12 OR MORE, EACH
60378	2" CURVED ROUND POINT	\$1.75	\$1.60
60379	2 1/2" CURVED ROUND POINT	1.75	1.60
60380	3" CURVED ROUND POINT	1.75	1.60
60381	4" CURVED ROUND POINT	2.00	1.80
60382	5" CURVED ROUND POINT	2.25	2.00
60383	6" CURVED ROUND POINT	2.25	2.00
60384	8" CURVED ROUND POINT	3.25	3.00
	3 SQUARE POINT NEEDLES		
60398	2" CURVED 3 SQUARE POINT	\$3.25	\$3.00
60391	2 1/2" CURVED 3 SQUARE POINT	3.25	3.00
60392	3" CURVED 3 SQUARE POINT	3.25	3.00
60393	4" CURVED 3 SQUARE POINT	3.75	3.50
60394	5" CURVED 3 SQUARE POINT	4.25	4.00
60395	6" CURVED 3 SQUARE POINT	4.75	4.50
60396	8" CURVED 3 SQUARE POINT	6.00	5.50

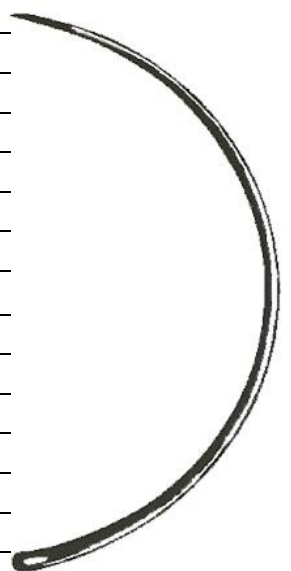

~ UPHOLSTERY PINS ~ TRIMMING KNIFE ~ REGULATORS ~ T-PINS ~ TWIST PINS ~

UPHOLSTERY PINS



3" NICKEL PLATED / 16 GAUGE

STOCK No.		1 PKG	3+ PKGS, PER PACKAGE	12+ PKGS, PER PACKAGE
60405	UPHOLSTERY PINS (PACKAGE OF 12)	\$4.50	\$4.25	\$4.00

AUTO TRIMMING KNIFE



USED FOR RIPPING SEAMS,
CUTTING CARPETING, VINYL, PLASTIC AND RUBBER.

STOCK No.		EACH
60592	#1020 AUTO TRIMMING KNIFE	\$39.95

LIGHT REGULATOR



8"
9 GAUGE

STOCK No.		EACH	12 OR MORE, EACH
60403	# 306.5 LIGHT REGULATOR	\$8.00	\$7.20

REGULATOR



8" WITH PLASTIC HANDLE

STOCK No.		EACH	12 OR MORE, EACH
60404	#520 REGULATOR	\$9.25	\$8.35

TWIST PINS

HOLDS FABRIC IN PLACE
RUST RESISTANT WITH CLEAR
PLASTIC TOP

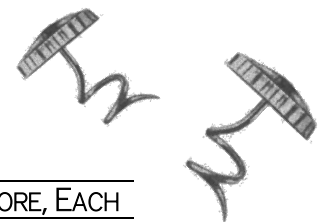
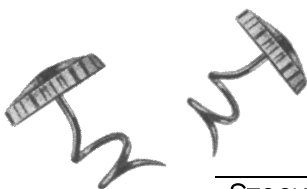

STOCK No.		EACH	5 PKG. OR MORE, EACH
60410	TWIST PINS, 100 PER PACKAGE	\$9.95	\$8.95

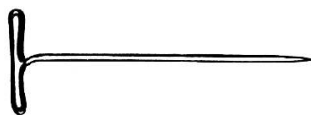

T-PINS

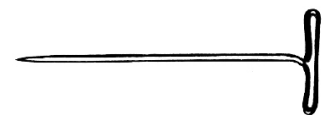

STOCK No.		PER BOX
60406	1 1/4" T-PINS (1/2 LB BOX, APPROX 1500 PINS PER BOX)	\$15.50

SEWING MACHINE
NEEDLES

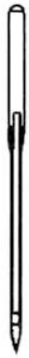

STOCK No.	FITS MACHINES AND MODELS	EACH	LOTS OF 10, EACH
85701	SIZE 16x63 FITS: SINGER 16-188	\$1.25	\$1.10
85702	SIZE 135x17 FITS: SINGER 110W, 111W JUKI 562, 563 CONSEW 118, 225, 226, 229, 255	1.25	1.10
85703	SIZE 190R FITS: PFAFF 145, 545, 1245	1.25	1.10



SEAT COVER TIES
 $\frac{3}{4}$ "
(425 TO 450 PER POUND)

#2 HOG RINGS

STOCK No.		1 LB.	5+ LBS., PER LB
60071	#2 HOG RINGS	\$3.45	\$3.10



SEAM EQUALIZER

STOCK No.	MAXIMUM LENGTH - 42 INCHES	EACH
60317	#267 CUSHION SEAM EQUALIZER/CUSHION STRETCHER	\$86.50

TRIMMING KNIFE



STOCK No.		EACH	6 OR MORE, EACH
60320	#76.5 TRIMMING KNIFE	\$10.25	\$9.25

VINYL ROLLER



STOCK No.		EACH
60585	#339 VINYL ROLLER	\$46.95

ALUMINUM RULE

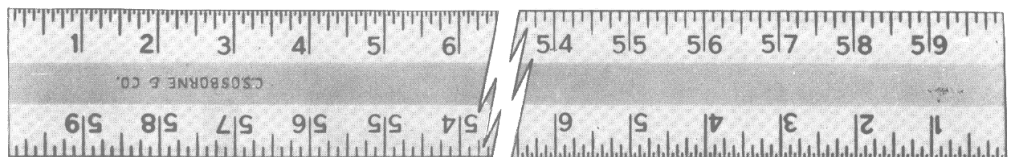

STOCK No.	#161 60 INCH ALUMINUM STRAIGHT RULE	EACH
60304	STANDARD AND METRIC MEASUREMENTS - $1\frac{1}{2}$ " WIDE	\$13.95

~ PLIERS ~

STRETCHING PLIERS

Stock No.		EACH	6 OR MORE, EACH
60307	#250 3 1/2" STRETCHING PLIERS	\$43.50	\$39.25



Stock No.		EACH	6 OR MORE, EACH
60308	#251 1 1/2" STRETCHING PLIERS	\$42.95	\$38.75



HOG RING PLIERS

Stock No.	STRAIGHT HOG RING PLIERS	EACH	
60323	#1440A HOG RING PLIERS (NO SPRING)	\$33.50	



Stock No.	BENT HANDLE HOG RING PLIERS	EACH	
60440	#1440B HOG RING PLIERS (NO SPRING)	\$35.95	



Stock No.	BENT HANDLE HOG RING PLIERS Make it easy to reach difficult places.	EACH	
60439	#1440C HOG RING PLIERS (NO SPRING)	\$35.95	



Stock No.	SPRING CLOSING HOG RING PLIERS	EACH	
60425	#1440BC SPRING CLOSING HOG RING PLIERS	\$37.95	

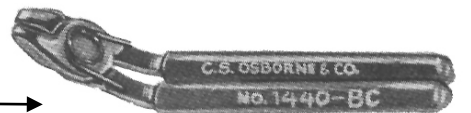

3-PRONG CLIP PLIERS

Stock No.		EACH	6 OR MORE, EACH
60312	#445 3-PRONG CLIP PLIERS	\$77.95	\$70.25



DIAGONAL PLIERS

Stock No.		EACH	6 OR MORE, EACH
60326	#3377 DIAGONAL PLIERS	\$10.95	\$9.85



~ AUTOMOTIVE SUPPLIES ~



AVAILABLE COLORS

COLORS MAY VARY SLIGHTLY FROM SAMPLES

AUTOMOTIVE HEADLINER	
100% NYLON, 54" WIDTH, 1/4" FOAM BACKING	\$7.95 PER YARD

622 ROYAL	622 CHARCOAL	622 BLACK
622 NAVY	622 CAMEL	622 CRIMSON
622 BURGUNDY		

SNAP-ON GENERAL PURPOSE/HEADLINER CLIP



STOCK No.	FOR FASTENING WHERE STAPLES OR GLUE CANNOT BE USED	EACH
93600	#9417 GENERAL PURPOSE CLIPS (100 PER BOX)	\$13.25

3-M GENERAL TRIM ADHESIVE

BONDS FOAM, LIGHTWEIGHT HEADLINERS, CARPET

STOCK No.		EACH	6+ CANS, EACH
18080	3M™ #8088 GENERAL TRIM ADHESIVE	\$24.75	\$22.50

18 Oz

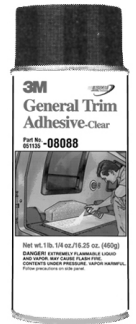

3-M SUPER TRIM ADHESIVE

BONDS VINYL TOPS, HEAVYWEIGHT HEADLINERS, AND HOOD SILENCER PADS.
USEFUL WHERE HIGH STRENGTH AND HEAT RESISTANCE ARE NEEDED.

STOCK No.		EACH	6+ CANS, EACH
18090	3M™ #8090 SUPER TRIM ADHESIVE	\$26.75	\$24.25

19 Oz



PANEL BOARDS

NOTICE: PLAIN PANEL BOARDS (STOCK No. 64867)

ARE TOO LARGE TO BE SHIPPED VIA UPS OR FEDEX

WEATHERPROOF PANEL BOARDS MUST BE SHIPPED IN LOTS OF 4 TO PREVENT DAMAGE.

STOCK No.		EACH	4 OR MORE, EACH
64848	32 x 48 WEATHERPROOF PANEL BOARDS (1/8" THICK)	\$11.95	\$10.95
64867	39 x 65 PLAIN PANEL BOARDS (3/32" THICK)	11.95	10.95

VINYL WELT CORD

EMBOSSED FINISH, HOLLOW BEAD, 3/8" SLIT
FLANGE FOR EASY TAILORING AND WORKABILITY.



CHECK STOCK FOR AVAILABLE COLORS

STOCK No.	COLOR	STOCK No.	COLOR
W1801	180-1 BONE	W1817	180-17 MED. BROWN
W1802	180-2 OFF-WHITE	W1818	180-18 BROWN
W1803	180-3 FIRETHORN	W1819	180-19 LT. BLUE
W1804	180-4 MED. GREEN	W1820	180-20 DK. GREEN
W1805	180-5 MAROON	W1821	180-21 DK. GREY
W1806	180-6 BRIGHT RED	W1822	180-22 SAND
W1807	180-7 RUST	W1823	180-23 PEWTER
W1808	180-8 GREY	W1824	180-24 WHITE
W1809	180-9 BLACK	W1825	180-25 MED. BLUE
W1810	180-10 MET. BLUE	W1826	180-26 BURGUNDY
W1811	180-11 DK. BLUE	W1827	180-27 NUTMEG
W1812	180-12 NAVY	W1828	180-28 CHARCOAL
W1813	180-13 BUCKSKIN	W1829	180-29 LT. MED. BLUE
W1814	180-14 TAN	W1830	180-30 MED. TURQUOISE
W1816	180-16 BEIGE		

	PER YARD	100 YARD ROLL, PER YARD
VINYL WELT	\$.70	\$.60

AUTOMOTIVE CARPET PAD

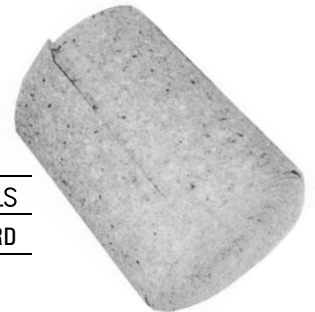

STOCK No.	APPROX 3/8" THICKNESS, 36" WIDTH	PER YARD	25 YARDS	50 YARD ROLLS
7620TA	CARPET PAD, 27 OZ.	\$5.50	\$5.25/YARD	\$4.95/YARD

HIDEM WELT CORD

STOCK No.	(5/8" WIDE)	PER YARD	25 YARD ROLLS/YARD
W1850	WHITE HIDEM WELT	\$1.25	\$1.15
W1854	BLACK HIDEM WELT	1.25	1.15

~ BUNGI / SHOCK CORD ~ CLEAR VINYL ~

BUNGI /
SHOCK CORD



STOCK NO.	TIE DOWN FOR BOAT COVERS, TARPS, ETC.	PER FT.	100 FT SPOOLS/PER FT.
93610	1/4" BUNGI/SHOCK CORD	\$.50	\$.45
93611	HOOCS FOR SHOCK CORD	.75/ EACH	10 OR MORE, \$.70 EACH

CLEAR VINYL

STOCK NO.	54 INCHES WIDE	PER YARD	25 YARD ROLL, PER YARD
1910CL	CLEAR VINYL, 16 GA.	\$6.25	\$5.75

RAZOR BLADES

STOCK NO.		EACH
64831	SINGLE EDGE RAZOR BLADE (100 PER PACKAGE)	\$9.95



Genuine Leather – Simuleather – Luxor - Luxor II – Symphony Collection - Leatherette

In addition to Genuine Leather, we offer man made, animal friendly, leather like fabrics that offer glove leather softness, superior tailor-ability, durability, and ease of care yet are approximately 35% more efficient than Genuine Leather because there is virtually no waste.

See our Vinyl book for samples and pricing or call us for information.

Marine and Awning Fabric

Our Pattern 1960.

Dickson Marine Fabrics Pattern Coastguard - Manufactured by Glen Raven Mills

60" Wide, 100% Solution Dyed Woven Acrylic

- Water Repellant
- Fade Resistant
- Mildew Resistant
- 5 Year Limited Warranty
- Available in 17 Popular Colors
- Approx 9.25 oz. Per Square Yard

See our Vinyl book for samples and pricing or call us for information.

Herculite®

Industrial & Marine Laminated Fabrics

FIRE RESISTANT – TEAR RESISTANT – IMPERMEABLE – MILDEW/ROT RESISTANT – ABRASION RESISTANT
ULTRAVIOLET RESISTANT – EASY TO CLEAN

Key Benefits

Extra Strength -Herculite fabrics are tear resistant and provide longer service life and more durable protection under the most rugged working conditions.

Self-Extinguishing -Inherently flame retardant, not just surface treated. "Snuffs out" as soon as flame source is removed.

Fluid proof -Liquids will not penetrate. Provides an impermeable barrier against fluids, gases, dust and other contaminants. Completely waterproof.

Inert- Resists mildew, most chemicals, oils, greases; will not rot.

Abrasion Resistant -Can sustain vigorous chafing action. Resists wear, stress, and punctures.

Easy To Handle -Comparatively lightweight coverings store compactly wet or dry, are easy to install and remove.

Weatherability -Retains its performance properties under sun, wind, rain; on shore or at sea. Ultraviolet resistant except for Clear (translucent) styles.

Soil Resistant -Easy to maintain; just soap and water does the job in most cases. Saves time and labor.

Simple Fabrication -By variety or combination of methods. Can be sewn, die-cut, cemented or electronically welded.

Electronic Welding -In addition to roll goods, available in large size rectangular or square sheets with air-tight, water-tight welded seams.

Typical Applications

Herculite 80 -Heavy Duty

MEETS MIL-C-43006 TYPE I, LATEST AMENDMENT

Awnings, Cargo Covers, Divider Curtains, Gym Floor Covers, Gym Mats, Hatch Tents, Heavy Duty Upholstery, Lifeboat Covers, Portable Shelters, Sandblast Screens, Shipping Room Curtains, Tank Liners, Tarpaulins and more.

Colors: White, Green, Yellow, Red, Gray, Navy Blue, Olive Drab, Black, Royal Blue

Herculite 20 -Medium Duty

MEETS MIL-C-43006, TYPE II, LATEST AMENDMENT

Aprons, Athletic Field Covers, Cart Covers, Chemical Covers, Equipment Covers, Fire Salvage Covers, Fumigation Blankets, Irrigation Liners, Lineman's Repair Tents, Snowmobile Covers, Storage Covers, Swim Pool Covers, Tarpaulins and more.

Colors: White, Green, Yellow, Navy Blue

Herculite 40 - Aqua-Tex® II

Pleasure Boating Fabrics

Awnings, Bimini Tops, Boom Covers, Cockpit Covers, Convertible Tops, Dodgers, Equipment Covers, Flying Bridge Covers, Mooring Covers, Navy Tops, Outboard Motor Covers, Side and Rear Curtains, Winch Covers and more.

Colors: White, Ivory, White/Blue

Typical Performance Properties

	Herculite 80		Herculite 20		Aqua-Tex II	
Fabric Weight	18 oz./sq. yd.		10 oz./sq. yd.		12.7 oz./sq. yd.	
Roll Length	50 yds.		100 yds.		45 yds.	
Roll Width	50 in.		54 in.		62 in.	
Roll Weight	78 lbs.		94 lbs.		63 lbs.	
Fabric Thickness	27 mils		14 mils		15 mils	
Flame Resistance						
Flame Time	0.6 sec.		0.6 sec.		0.5 sec.	
Char Length	2.9 in.		4.3 in.		4.4 in.	
Breaking Strength	Warp 342 lbs.	Fill 338 lbs.	Warp 135 lbs.	Fill 137 lbs.	Warp 199 lbs.	Fill 146 lbs.
Tear Resistance	129 lbs.	140 lbs.	39 lbs.	43 lbs.	42 lbs.	44 lbs.
Hydrostatic Resistance	590 PSI		234 PSI		282 PSI	
Adhesion (peel)	15.3 lbs.		7.2 lbs.		9.3 lbs.	

See our Vinyl book for samples and pricing or call us for information.

PATTERNS: IMPACT AND TITAN

Premium Coated Vinyls
TYPICAL PERFORMANCE PROPERTIES (AVERAGE)*

	IMPACT LEATHER FINISH	TITAN MATTE FINISH
TOTAL WEIGHT	16 OZ./ SQ. YD.	18.5 OZ. / SQ. YD.
WIDTH	61"	61"
YARN	POLYESTER	POLYESTER
YARN COUNT	20 X 20/1"	20 X 20/1"
GRAB TENSILE	450 X 505 LBS	375 X 375 LBS
TOUNGE TEAR	85 X 95 LBS	100 X 100 LBS
ADHESION	25 LBS./2"	26 LBS./2"
COLD CRACK	-30 DEGREES F.	-30 DEGREES F.
TREATMENTS	Anti mildew, UV Pigment	Anti mildew, UV Pigment
(6P) PHTHALATES	Less than 0.1% Complies with CPSC Standards	
LEAD	Less than 100 PPM Complies with CPSC Standards	
FLAME RESISTANCE	ASTM E-84 CLASS A CSFM TITLE 10 – NFPA 701	CSFM TITLE 19 NFPA 701
ROLL SIZE	25 YD. ROLLS	25 YD. ROLLS
APPLICATIONS:	<ul style="list-style-type: none"> ● Wall Pads ● Floor Mats ● Child Development Products ● Athletic Dummies/Pads ● Gym Mats ● Pole Vault ● Jump Pits ● Cart Covers ● Equipment Covers ● Storage Covers 	<ul style="list-style-type: none"> ● Truck Covers ● Containment Booms ● Insulated Bulkheads ● Dock Seals ● Curing Blankets ● Laundry Carts ● Tarpaulins ● General Purpose Covers ● Lifeboat Covers ● Tank Liners ● Heavy Duty Upholstery

*Chemical and physical properties of these products are based upon reliable testing methods. While reliable they are intended only as an informational source for your benefit and do not constitute any warranty or guarantee.

PATTERN IMPACT IS AVAILABLE IN 9 COLORS:

**BLACK – GREEN – GREY – NAVY – OCEAN
RED – ROYAL - WHITE – YELLOW**

PATTERN TITAN IS AVAILABLE IN 8 COLORS:

**BLACK – GREEN – GREY – RED – ROYAL - WHITE
YELLOW**

See our Vinyl book for samples and pricing or call us for information.